

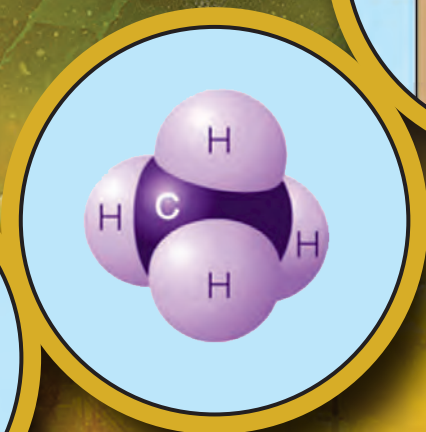

# SCIENCE AND TECHNOLOGY

STANDARD TEN

PART-1

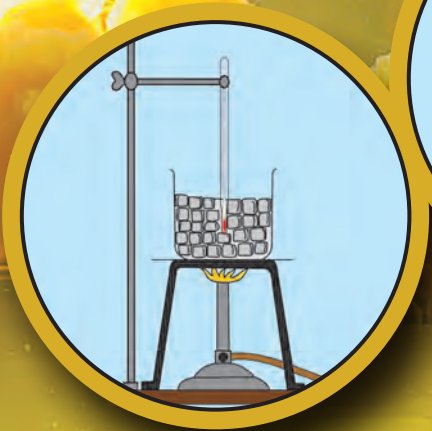
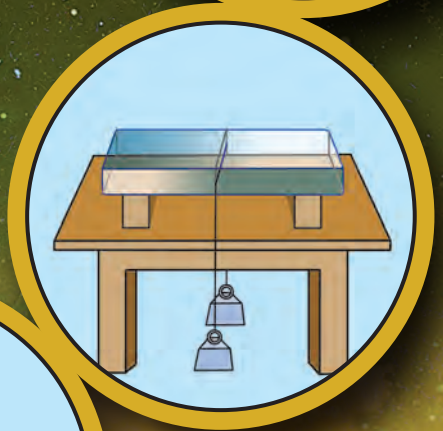
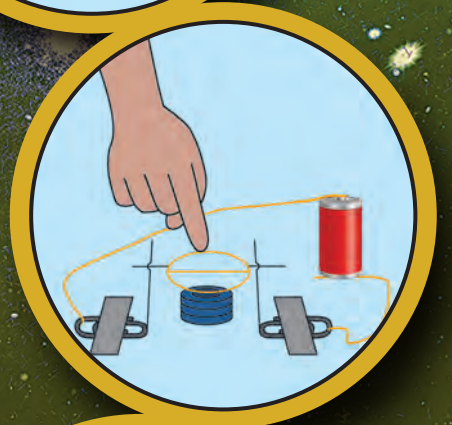
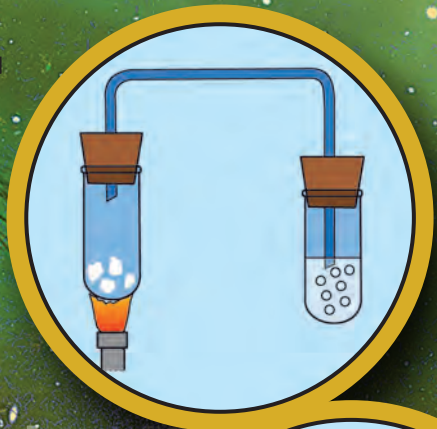

$\Omega$

# The Constitution of India

## Chapter IV A

### Fundamental Duties

#### ARTICLE 51A

**Fundamental Duties- It shall be the duty of every citizen of India—**

- (a) to abide by the Constitution and respect its ideals and institutions, the National Flag and the National Anthem;
- (b) to cherish and follow the noble ideals which inspired our national struggle for freedom;
- (c) to uphold and protect the sovereignty, unity and integrity of India;
- (d) to defend the country and render national service when called upon to do so;
- (e) to promote harmony and the spirit of common brotherhood amongst all the people of India transcending religious, linguistic and regional or sectional diversities, to renounce practices derogatory to the dignity of women;
- (f) to value and preserve the rich heritage of our composite culture;
- (g) to protect and improve the natural environment including forests, lakes, rivers and wild life and to have compassion for living creatures;
- (h) to develop the scientific temper, humanism and the spirit of inquiry and reform;
- (i) to safeguard public property and to abjure violence;
- (j) to strive towards excellence in all spheres of individual and collective activity so that the nation constantly rises to higher levels of endeavour and achievement;
- (k) who is a parent or guardian to provide opportunities for education to his child or, as the case may be, ward between the age of six and fourteen years.



Permission is granted for enforcing this textbook from the academic year 2018-19 in the meeting, held on the date 29.12.2017, of the coordination committee constituted by the Government resolution No: Abhyas-2116/(Pra.kra.43/16) S.D-4 dated 25.4.2016



# SCIENCE AND TECHNOLOGY

STANDARD TEN

**PART-1**



**Maharashtra State Bureau of Textbook Production and Curriculum Research, Pune.**



HMTQBV

The digital textbook can be obtained through DIKSHA App on your smartphone by using the Q.R.Code given on title page of the textbook and useful audio-visual teaching-learning material of the relevant lesson will be available through the Q.R. Code given in each lesson of this textbook.

**First Edition : 2018**

**Reprint : 2022**

© Maharashtra State Bureau of Textbook Production  
and Curriculum Research, Pune - 411 004.

The Maharashtra State Bureau of Textbook Production and Curriculum Research reserves all rights relating to the book. No part of this book should be reproduced without the written permission of the Director, Maharashtra State Bureau of Textbook Production and Curriculum Research, 'Balbharati', Senapati Bapat Marg, Pune 411004.

**Science Subject Committee :**

**Dr. Chandrashekar Murumkar, Chairman**

Dr. Dilip Sadashiv Joag, Member

Dr. Sushama Dilip Joag, Member

Dr. Pushpa Khare, Member

Dr. Imtiaz Sirajuddin Mulla, Member

Dr. Jaydeep Vinayak Sali, Member

Dr. Abhay Jere, Member

Dr. Sulabha Nitin Vidhate, Member

Smt. Mrinalini Desai, Member

Shri. Gajanan Suryawanshi, Member

Shri. Sudhir Yadavrao Kamble, Member

Smt. Dipali Dhananjay Bhale, Member

Shri. Rajiv Arun Patole, Member-Secretary

**Science Study Group :**

Dr. Prabhakar Nagnath Kshirsagar

Dr. Vishnu Vaze

Dr. Prachi Rahul Choudhary

Dr. Shaikh Mohammed Waquiuddin H.

Dr. Ajay Digambar Mahajan

Dr. Gayatri Gorakhnath Choukade

Shri. Prashant Panditrao Kolse

Shri. Sandip Popatlal Chordiya

Shri. Sachin Ashok Bartakke

Smt. Shweta Dilip Thakur

Shri. Rupesh Dinkar Thakur

Shri. Dayashankar Vishnu Vaidya

Shri. Sukumar Shrenik Navale

Shri. Gajanan Nagoraaji Mankar

Shri. Mohammed Atique Abdul Shaikh

Smt. Anjali Lakshmikant Khadke

Smt. Manisha Rajendra Dahivelkar

Smt. Jyoti Medpilwar

Smt. Dipti Chandansingh Bisht

Smt. Pushpalata Gawande

Smt. Anita Patil

Smt. Kanchan Rajendra Sorate

Shri. Rajesh Vamanrao Roman

Shri. Nagesh Bhimsevak Telgote

Shri. Shankar Bhikan Rajput

Shri. Manoj Rahangdale

Shri. Hemant Achyut Lagvankar

Smt. Jyoti Damodar Karane

Shri. Vishwas Bhawe

**Cover and Illustrations :**

Shri. Vivekanand Shivshankar Patil

Ashana Advani

**Typesetting :**

DTP Section, Textbook Bureau, Pune

**Coordination :**

**Rajiv Arun Patole**

Special Officer for Science

**Translation :**

Dr. Sushma Dilip Joag

Dr. Pushpa Khare

Dr. Dilip Sadashiv Joag

**Scrutiny :**

Dr. Imtiaz S. Mulla

Dr. Jaydeep Vinayak Sali

**Paper :**

70 GSM Creamwove

**Print Order :**

**Printer :**

**Production :**

**Sachchitanand Aphale**

Chief Production Officer

**Rajendra Vispute**

Production Officer

**Publisher :**

**Vivek Uttam Gosavi**

Controller

Maharashtra State Textbook Bureau,  
Prabhadevi, Mumbai - 400 025.





## The Constitution of India

### Preamble

WE, THE PEOPLE OF INDIA, having solemnly resolved to constitute India into a SOVEREIGN SOCIALIST SECULAR DEMOCRATIC REPUBLIC and to secure to all its citizens:

JUSTICE, social, economic and political;

LIBERTY of thought, expression, belief, faith and worship;

EQUALITY of status and of opportunity; and to promote among them all

FRATERNITY assuring the dignity of the individual and the unity and integrity of the Nation;

IN OUR CONSTITUENT ASSEMBLY this twenty-sixth day of November, 1949, do HEREBY ADOPT, ENACT AND GIVE TO OURSELVES THIS CONSTITUTION.

## NATIONAL ANTHEM

Jana-gana-mana-adhināyaka jaya hē  
Bhārata-bhāgya-vidhātā,

Panjāba-Sindhu-Gujarāta-Marāthā  
Drāvida-Utkala-Banga

Vindhya-Himāchala-Yamunā-Gangā  
uchchala-jaladhi-taranga

Tava subha nāmē jāgē, tava subha āsisa māgē,  
gāhē tava jaya-gāthā,

Jana-gana-mangala-dāyaka jaya hē  
Bhārata-bhāgya-vidhātā,

Jaya hē, Jaya hē, Jaya hē,  
Jaya jaya jaya, jaya hē.

## PLEDGE

India is my country. All Indians  
are my brothers and sisters.

I love my country, and I am proud  
of its rich and varied heritage. I shall  
always strive to be worthy of it.

I shall give my parents, teachers  
and all elders respect, and treat  
everyone with courtesy.

To my country and my people,  
I pledge my devotion. In their  
well-being and prosperity alone lies  
my happiness.



## Preface

Dear students

Welcome to Std X. We have great pleasure in offering you this Science and Technology textbook based on the new syllabus. From the primary level till today, you have studied science from various textbooks. In this textbook, you will be able to study the fundamental concepts of science and technology from a different point of view through the medium of the different branches of Science.

The basic purpose of this textbook Science and Technology Part-1 can be said to be 'Understand and explain to others' the science and technology that relates to our everyday life. While studying the concepts, principles and theories in science, do make the effort to understand their connection with day to day affairs. While studying from this textbook, use the sections 'Can you recall?' and 'Can you tell?' for revision. You will learn science through the many activities given under the titles such as 'Observe and discuss' and 'Try this' or 'Let's try this. Make sure that you perform all these activities. Activities like 'Use your brain power!', 'Research', 'Think about it' will stimulate your power of thinking.

Many experiments have been included in the textbook. Carry out these experiments yourself, following the given procedure and making your own observations. Ask your teachers, parents or classmates for help whenever you need it. Interesting information which reveals the science underlying the events we commonly observe, and the technology developed on its basis, has been given in details in this textbook through several activities. In this world of rapidly developing technology, you have already become familiar with computers and smartphones. While studying the textbook, make full and proper use of the devices of information communication technology, which will make your studies easier. For more effective studies, you can avail additional audio-visual material for each chapter using the Q.R code through an App. This will definitely help you in your studies.

While carrying out the given activities and experiments, take all precautions with regard to handling apparatus, chemicals, etc. and encourage others to take the same precautions.

It is expected that while carrying out activities or observation involving plants and animals, you will also make efforts towards conservation of the environment. You must of course take all the care to avoid causing any harm or injury to them.

Do tell us about the parts that you like, as well as about the difficulties that you face as you read and study and understand this textbook.

Our best wishes for your academic progress.



(Dr. Sunil Magar)

Pune

Date : 18 March 2018, Gudhipadva  
Indian Solar Year : 27 Phalgun 1939

Director  
Maharashtra State Bureau of Textbook  
and Curriculum Research, Pune

## For Teachers

- In Standards I to V we have told the simple science in day to day life through the study of surroundings. In VI to VIII standard we have given brief introduction to science. In the textbook 'Science and Technology' for standard IX we have given the relation between science and technology.
- The real objective of science education is to learn to be able to think logically and with discretion about events that are happening around us.
- In view of the age group of Std X students, it would be appropriate, in the process of science education, to give freedom and scope to the students' own curiosity about the events of the world, their propensity to go looking for the causes behind them and to their own initiative and capacity to take the lead.
- As experimental skills are necessary for observation, logic, estimation, comparison and application of information obtained in science education, deliberate efforts must be made to develop these skills while dealing with laboratory experiments given in the textbook. All observations that the students have noted should be accepted, and then they should be helped to achieve the expected results.
- These two years in middle school lay the foundation of higher education in Science. Hence, it is our responsibility to enrich and enhance student's interest in science. You all will of course always actively pursue the objective of imbuing them with a scientific temper in them and developing their creativity and along with internet and skill.
- You can use 'Let's recall' to review the previous knowledge required for a lesson and 'Can you tell?' to introduce a topic by eliciting all the knowledge that the students already have about it from their own reading or experience. You may of course use any of your own activities or questions that occur to you for this purpose. Activities given under 'Try this' and 'Let's try this' help to explain the content of the lesson. The former are for students to do themselves and the latter are those that you are expected to demonstrate. 'Use your brain power!' is meant for application of previous knowledge for the new lesson, and 'Always remember' gives important suggestions/information or values. 'Research', 'Find out', 'Do you know?', 'Introduction to scientists' and 'Institutes at work' are meant to give some information about the world outside the textbook and to develop the habit of doing independent reference work to obtain additional information.
- This textbook is not only meant for reading and explaining in the classroom but is also for guiding students to learn the methods of gaining knowledge by carrying out the given activities. An informal atmosphere in the classroom is required to achieve the aims of this textbook. maximum number of students should be encouraged to participate in discussions, experiments and activities. Special efforts should be made to organise presentations or report-reading in the class based on students' activities and projects, besides observing of Science Day and other relevant occasions/ days.
- The science and technology content of the textbook has been complemented with Information Communication Technology. These activities are to be conducted under your guidance while learning various new scientific concepts.

**Front and back covers :** Pictures of various activities, experiments and concepts in the book.

DISCLAIMER Note : All attempts have been made to contact copy righters (©) but we have not heard from them. We will be pleased to acknowledge the copy right holder (s) in our next edition if we learn from them.



## Competency Statements

The students are expected to achieve the following competency level after studying the text book **Science and Technology Part 1**

### **Motion, Force and Machines**

- \* To be able to explain the scientific reasons behind various phenomena on the basis of relationship between gravitational force and motion.
- \* To be able to write formulae describing the relations between gravitation and motion and using these solve various numerical problems.

### **Energy**

- \* To adapt an environment friendly lifestyle taking into account the grave effects of energy crisis and to encourage others to adapt it.
- \* To prepare, use and repair the equipments based on energy.
- \* To verify the laws of current electricity and to draw conclusions based on them
- \* To develop to solve numerical problems based on effects of current electricity.
- \* To observe various apparatus based on effects of current electricity and explain their functions with reasons.
- \* To give a scientific explanation of the images formed by lenses by drawing accurate ray diagrams.
- \* To explain properties of light, the images formed by lenses and their use in different equipments used in day to day life.
- \* To find out the focal length of a lens using given data.
- \* To study defects of vision in human eye and their remedies
- \* To draw neat and labelled diagram of human eye.

### **Substances in our use**

- \* To explain systematic classifications of elements and their positions in the periodic table.
- \* To identify type of chemical reaction in two components.
- \* To verify chemical reaction experimentally and draw conclusions.
- \* To correct the chemical equation which is incomplete or wrong.
- \* To verify the properties of carbon compounds through experiments.
- \* To take proper care while performing the experiments and handling of the apparatus considering the effects of chemical reactions on human health.
- \* To guide the society through scientific attitude about the use of carbon compounds in daily life.
- \* To understand the relationship between chemical reaction of metals in daily life and use them to solve various problem.

### **The Universe**

- \* To analyse the information obtained from space research and remove superstitions prevailing in society.
- \* To review the contribution made by India to space research.
- \* To search for future opportunities in the field of space research.

### **Information Communication technology (ICT)**

- \* To use information communication Technology in day today life.
- \* To share the information about science and technology by using the internet.
- \* To explain amazing things that have occurred in fields by using information communication technology

## Index

Sr No. Title of Lesson

Page No.

1. Gravitation.....	1
2. Periodic Classification of Element.....	16
3. Chemical reactions and equations.....	30
4. Effects of electric current .....	47
5. Heat .....	62
6. Refraction of light .....	73
7. Lenses .....	80
8. Metallurgy .....	93
9. Carbon compounds.....	110
10. Space Missions.....	135

### Academic Planning

Two separate books have been prepared for Science and technology. Science and technology part 1 contains ten chapters mainly related to physics and chemistry. While thinking about science and technology, it is expected that an integrated approach will be taken while teaching and a connection will be made between different components of science and technology. In previous standards, we have studied various topics in science and technology together. For technical case two separate books science and technology part 1 and part 2 have been prepared, but it is necessary that an integrated perspective be taken while teaching.

Out of the ten chapters included in text book science and technology part 1, the first five chapters are expected to be taught in the first session while the next five chapters in the second session. At the end of a session a written examination for 40 marks and a practical examination for ten marks should be conducted. Exercises and projects have been given at the end of every chapters in the text book.

In view of evaluation, representative questions similar to those in the activity sheets of language books are given in exercises. You may make similar other questions for your use. The students should be evaluated based on these questions detailed information above to this will be given in separate evaluation scheme.



# 1. Gravitation



- Gravitation
- Kepler's laws
- Acceleration due to the gravitational force of the Earth
- Free fall
- Circular motion and centripetal force
- Newton's universal law of gravitation
- Escape velocity



**Can you recall?**

1. What are the effects of a force acting on an object?
2. What types of forces are you familiar with?
3. What do you know about the gravitational force?

We have seen in the previous standard that the gravitational force is a universal force and it acts not only between two objects on the earth but also between any two objects in the universe. Let us now learn how this force was discovered.

## Gravitation

As we have learnt, the phenomenon of gravitation was discovered by Sir Isaac Newton. As the story goes, he discovered the force by seeing an apple fall from a tree on the ground. He wondered why all apples fall vertically downward and not at an angle to the vertical. Why do they not fly off in a horizontal direction?

After much thought, he came to the conclusion that the earth must be attracting the apple towards itself and this attractive force must be directed towards the center of the earth. The direction from the apple on the tree to the center of the earth is the vertical direction at the position of the apple and thus, the apple falls vertically downwards.

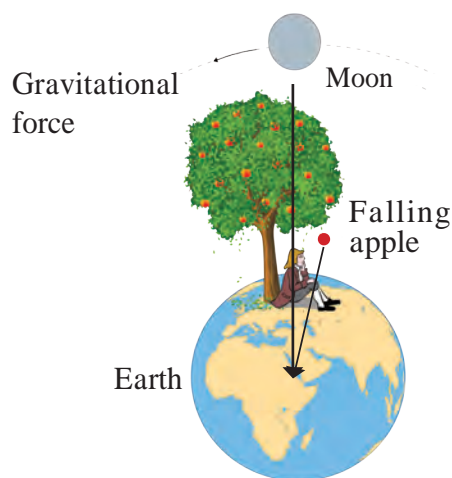

### 1.1 Concept of the gravitational force and the gravitational force between the earth and the moon.

Figure 1.1 on the left shows an apple tree on the earth. The force on an apple on the tree is towards the center of the earth i.e. along the perpendicular from the position of the apple to the surface of the earth. The Figure also shows the gravitational force between the earth and the moon. The distances in the figure are not according to scale.

Newton thought that if the force of gravitation acts on apples on the tree at different heights from the surface of the earth, can it also act on objects at even greater heights, much farther away from the earth, like for example, the moon? Can it act on even farther objects like the other planets and the Sun?

**Use of ICT :** Collect videos and ppts about the gravitational force of different planets.

## Force and Motion

We have seen that a force is necessary to change the speed as well as the direction of motion of an object.



**Can you recall?**

What are Newton's laws of motion?

## Introduction to scientist



Great Scientists: Sir Isaac Newton (1642-1727) was one of the greatest scientists of recent times. He was born in England. He gave his laws of motion, equations of motion and theory of gravity in his book Principia. Before this book was written, Kepler had given three laws describing planetary motions. However, the reason why planets move in the way described by Kepler's laws was not known. Newton, with his theory of gravity, mathematically derived Kepler's laws.

In addition to this, Newton did ground breaking work in several areas including light, heat, sound and mathematics. He invented a new branch of mathematics. This is called calculus and has wide ranging applications in physics and mathematics. He was the first scientist to construct a reflecting telescope.

## Circular motion and Centripetal force



### Try this

Tie a stone to one end of a string. Take the other end in your hand and rotate the string so that the stone moves along a circle as shown in figure 1.2 a. Are you applying any force on the stone? In which direction is this force acting? How will you stop this force from acting? What will be the effect on the stone?

As long as we are holding the string, we are pulling the stone towards us i.e. towards the centre of the circle and are applying a force towards it. The force stops acting if we release the string. In this case, the stone will fly off along a straight line which is the tangent to the circle at the position of the stone when the string is released, because that is the direction of its velocity at that instant of time (Figure 1.2 b). You may recall that we have performed a similar activity previously in which a 5 rupee coin kept on a rotating circular disk flies off the disk along the tangent to the disk. Thus, a force acts on any object moving along a circle and it is directed towards the centre of the circle. This is called the **Centripetal force**. 'Centripetal' means centre seeking, i.e. the object tries to go towards the centre of the circle because of this force.

You know that the moon, which is the natural satellite of the earth, goes round it in a definite orbit. The direction of motion of the moon as well as its speed constantly changes during this motion. Do you think some force is constantly acting on the moon? What must be the direction of this force? How would its motion have been if no such force acted on it? Do the other planets in the solar system revolve around the Sun in a similar fashion? Is similar force acting on them? What must be its direction?

From the above activity, example and questions it is clear that for the moon to go around the earth, there must be a force which is exerted on the moon and this force must be exerted by the earth which attracts the moon towards itself. Similarly, the Sun must be attracting the planets, including the earth, towards itself.

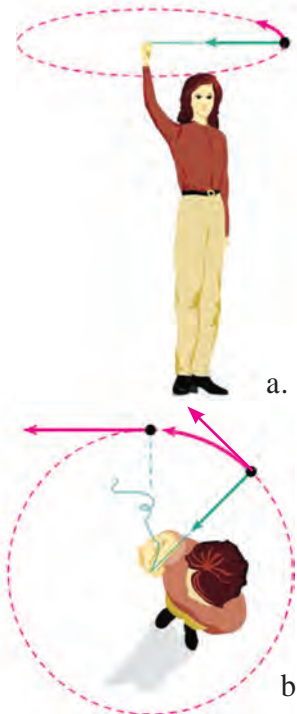

**1.2 A stone tied to a string, moving along a circular path and its velocity in tangential direction**

## Kepler's Laws

Planetary motion had been observed by astronomers since ancient times. Before Galileo, all observations of the planet's positions were made with naked eyes. By the 16th century a lot of data were available about planetary positions and motion. Johannes Kepler, studied these data. He noticed that the motion of planets follows certain laws. He stated three laws describing planetary motion. These are known as Kepler's laws which are given below.



### Do you know ?

An ellipse is the curve obtained when a cone is cut by an inclined plane. It has two focal points. The sum of the distances to the two focal points from every point on the curve is constant.  $F_1$  and  $F_2$  are two focal points of the ellipse shown in figure 1.3. If A, B and C are three points on the ellipse then,

$$AF_1 + AF_2 = BF_1 + BF_2 = CF_1 + CF_2$$

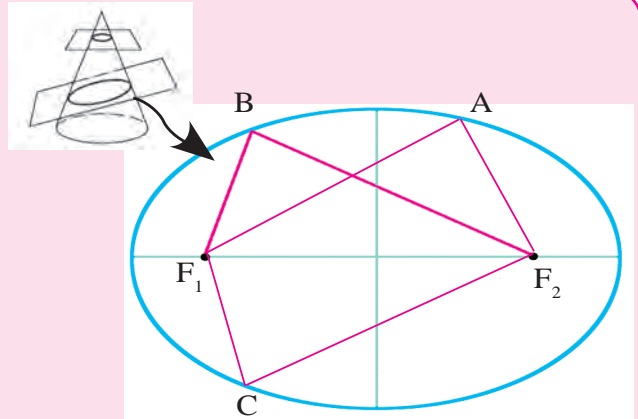

1.3 An ellipse

### Kepler's first law :

**The orbit of a planet is an ellipse with the Sun at one of the foci.**

Figure 1.4 shows the elliptical orbit of a planet revolving around the sun. The position of the Sun is indicated by S.

### Kepler's second law :

**The line joining the planet and the Sun sweeps equal areas in equal intervals of time.**

AB and CD are distances covered by the planet in equal time i.e. after equal intervals of time, the positions of the planet starting from A and C are shown by B and D respectively.

The straight lines AS and CS sweep equal area in equal interval of time i.e. area ASB and CSD are equal.

### Kepler's third law :

**The square of its period of revolution around the Sun is directly proportional to the cube of the mean distance of a planet from the Sun.**

Thus, if  $r$  is the average distance of the planet from the Sun and  $T$  is its period of revolution then,

$$T^2 \propto r^3 \text{ i.e. } \frac{T^2}{r^3} = \text{constant} = K \dots\dots\dots (1)$$

Kepler obtained these laws simply from the study of the positions of planets obtained by regular observations. He had no explanation as to why planets obey these laws. We will see below how these laws helped Newton in the formulation of his theory of gravitation.

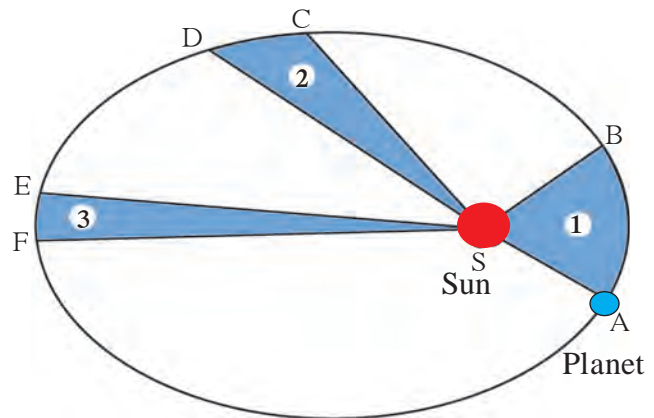

1.4 The orbit of a planet moving around the Sun.





### Use your brain power

If the area ESF in figure 1.4 is equal to area ASB, what will you infer about EF?

### Newton's universal law of gravitation

All the above considerations including Kepler's laws led Newton to formulate his theory of Universal gravity. According to this theory, every object in the Universe attracts every other object with a definite force. This force is directly proportional to the product of the masses of the two objects and is inversely proportional to the square of the distance between them.

### An introduction to scientists



Johannes Kepler (1571-1630) was a German astronomer and mathematician. He started working as a helper to the famous astronomer Tycho Brahe in Prague in 1600. After the sudden death of Brahe in 1601, Kepler was appointed as the Royal mathematician in his place. Kepler used the observations of planetary positions made by Brahe to discover the laws of planetary motion. He wrote several books. His work was later used by Newton in postulating his law of gravitation.

Figure 1.5 shows two objects with masses  $m_1$  and  $m_2$  kept at a distance  $d$  from each other. Mathematically, the gravitational force of attraction between these two bodies can be written as

$$F \propto \frac{m_1 m_2}{d^2} \quad \text{or} \quad F = G \frac{m_1 m_2}{d^2} \quad \dots\dots (2)$$

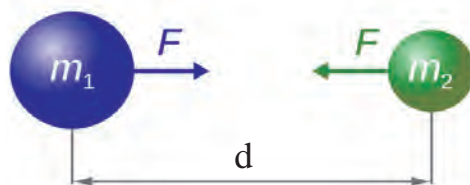

1.5 Gravitational force between two objects

Here,  $G$  is the constant of proportionality and is called the Universal gravitational constant.

The above law means that if the mass of one object is doubled, the force between the two objects also doubles. Also, if the distance is doubled, the force decreases by a factor of 4. If the two bodies are spherical, the direction of the force is always along the line joining the centres of the two bodies and the distance between the centres is taken to be  $d$ . In case when the bodies are not spherical or have irregular shape, then the direction of force is along the line joining their centres of mass and  $d$  is taken to be the distance between the two centres of mass.

From equation (2), it can be seen that the value of  $G$  is the gravitational force acting between two unit masses kept at a unit distance away from each other. Thus, in SI units, the value of  $G$  is equal to the gravitational force between two masses of 1 kg kept 1 m apart.



### Use your brain power

Show that in SI units, the unit of  $G$  is Newton  $\text{m}^2 \text{kg}^{-2}$ . The value of  $G$  was first experimentally measured by Henry Cavendish. In SI units its value is  $6.673 \times 10^{-11} \text{ N m}^2 \text{kg}^{-2}$ .

The centre of mass of an object is the point inside or outside the object at which the total mass of the object can be assumed to be concentrated. The centre of mass of a spherical object having uniform density is at its geometrical centre. The centre of mass of any object having uniform density is at its centroid.

Why did Newton assume inverse square dependence on distance in his law of gravitation? He was helped by Kepler's third law in this as shown below.

### Uniform circular motion / Magnitude of centripetal force

Consider an object moving in a circle with constant speed. We have seen earlier that such a motion is possible only when the object is constantly acted upon by a force directed towards the centre of the circle. This force is called the centripetal force. If  $m$  is the mass of the object,  $v$  is its speed and  $r$  is the radius of the circle, then it can be shown that this force is equal to  $F = m v^2/r$ .

If a planet is revolving around the Sun in a circular orbit in uniform circular motion, then the centripetal force acting on the planet towards the Sun must be  $F = mv^2/r$ , where,  $m$  is the mass of the planet,  $v$  is its speed and  $r$  is its distance from the Sun.

$$\text{Speed} = \frac{\text{distance travelled}}{\text{time taken}}$$

The speed of the planet can be expressed in terms of the period of revolution  $T$  as follows.

The distance travelled by the planet in one revolution = perimeter of the orbit  $2 \pi r$  ;  
 $r$  = distance of the planet from the Sun, Time taken = Period of revolution =  $T$

$$v = \frac{\text{distance travelled}}{\text{time taken}} = \frac{2\pi r}{T}$$

$$F = \frac{mv^2}{r} = \frac{m \left( \frac{2 \pi r}{T} \right)^2}{r} = \frac{4 m \pi^2 r}{T^2}, \text{ multiplying and dividing by } r^2 \text{ we get,}$$

$$F = \frac{4 m \pi^2}{r^2} \times \left( \frac{r^3}{T^2} \right). \text{ According to Kepler's third law, } \frac{T^2}{r^3} = K$$

$$F = \frac{4 m \pi^2}{r^2 K}, \text{ But } \frac{4 m \pi^2}{K} = \text{Constant} \therefore F = \text{constant} \times \frac{1}{r^2} \therefore F \propto \frac{1}{r^2}$$

Thus, Newton concluded that the centripetal force which is the force acting on the planet and is responsible for its circular motion, must be inversely proportional to the square of the distance between the planet and the Sun. Newton identified this force with the force of gravity and hence postulated the inverse square law of gravitation. The gravitational force is much weaker than other forces in nature but it controls the Universe and decides its future. This is possible because of the huge masses of planets, stars and other constituents of the Universe.



### Use your brain power

Is there a gravitational force between two objects kept on a table or between you and your friend sitting next to you? If yes, why don't the two move towards each other?

## Solved examples

**Example 1 :** Mahendra and Virat are sitting at a distance of 1 metre from each other. Their masses are 75 kg and 80 kg respectively. What is the gravitational force between them?

**Given :**  $r = 1 \text{ m}$ ,  $m_1 = 75 \text{ kg}$ ,  $m_2 = 80 \text{ kg}$  and  $G = 6.67 \times 10^{-11} \text{ Nm}^2/\text{kg}^2$

According to Newton's law

$$F = \frac{G m_1 m_2}{r^2}$$

$$F = \frac{6.67 \times 10^{-11} \times 75 \times 80}{1^2} \text{ N}$$

$$= 4.002 \times 10^{-7} \text{ N}$$

The gravitational force between Mahendra and Virat is  $4.002 \times 10^{-7} \text{ N}$

This is a very small force. If the force of friction between Mahendra and the bench on which he is sitting is zero, then he will start moving towards Virat under the action of this force. We can calculate his acceleration and velocity by using Newton's laws of motion.

**Example 2 :** In the above example, assuming that the bench on which Mahendra is sitting is frictionless, starting with zero velocity, what will be Mahendra's velocity of motion towards Virat after 1 s ? Will this velocity change with time and how?



**Use your brain power !**

Assuming the acceleration in Example 2 above remains constant, how long will Mahendra take to move 1 cm towards Virat?



**Do you know ?**

You must be knowing about the high and low tides that occur regularly in the sea. The level of sea water at any given location along sea shore increases and decreases twice a day at regular intervals. High and low tides occur at different times at different places. The level of water in the sea changes because of the gravitational force exerted by the moon. Water directly under the moon gets pulled towards the moon and the level of water there goes up causing high tide at that place. At two places on the earth at  $90^\circ$  from the place of high tide, the level of water is minimum and low tides occur there as shown in figure 1.6

**Given:** Force on Mahendra =  $F = 4.002 \times 10^{-7} \text{ N}$ , Mahendra's mass =  $m = 75 \text{ kg}$

According to Newton's second law, the acceleration produced by the force on Mahendra =  $m = 75 \text{ kg}$ .

$$a = \frac{F}{m} = \frac{4.002 \times 10^{-7}}{75} = 5.34 \times 10^{-9} \text{ m/s}^2$$

Using Newton's first equation, we can calculate Mahendra's velocity after 1s, Newton's first equation of motion is

$$v = u + a t;$$

As Mahendra is sitting on the bench, his initial velocity is zero ( $u=0$ )

Assuming the bench to be frictionless,

$$\begin{aligned} v &= 0 + 5.34 \times 10^{-9} \times 1 \text{ m/s} \\ &= 5.34 \times 10^{-9} \text{ m/s} \end{aligned}$$

Mahendra's velocity after 1 s will be  $5.34 \times 10^{-9} \text{ m/s}$ .

This is an extremely small velocity. The velocity will increase with time because of the acceleration. The acceleration will also not remain constant because as Mahendra moves towards Virat, the distance between them will decrease, causing an increase in the gravitational force, thereby increasing the acceleration as per Newton's second law of motion.



**1.6 Low and high tides**



Collect information about high and low tides from geography books. Observe the timing of high and low tides at one place when you go for a picnic to be a beach. Take pictures and hold an exhibition.

### Earth' gravitational force

Will the velocity of a stone thrown vertically upwards remain constant or will it change with time? How will it change? Why doesn't the stone move up all the time? Why does it fall down after reaching a certain height? What does its maximum height depend on ?

The earth attracts every object near it towards itself because of the gravitational force. The centre of mass of the earth is situated at its centre, so the gravitational force on any object due to the earth is always directed towards the centre of the earth. Because of this force, an object falls vertically downwards on the earth.

Similarly, when we throw a stone vertically upwards, this force tries to pull it down and reduces its velocity. Due to this constant downward pull, the velocity becomes zero after a while. The pull continues to be exerted and the stone starts moving vertically downward towards the centre of the earth under its influence.

### Solved Examples

**Example 1:** Calculate the gravitational force due to the earth on Mahendra in the earlier example.

**Given:** Mass of the earth =  $m_1 = 6 \times 10^{24}$  kg  
 Radius of the earth =  $R = 6.4 \times 10^6$  m  
 Mahendra's mass =  $m_2 = 75$  kg  
 $G = 6.67 \times 10^{-11}$  Nm<sup>2</sup>/kg<sup>2</sup>

Using the force law, the gravitational force on Mahendra due to earth is given by

This force is  $1.83 \times 10^9$  times larger than the gravitational force between Mahendra and Virat.

$$F = \frac{G m_1 m_2}{R^2}$$

$$F = \frac{6.67 \times 10^{-11} \times 75 \times 6 \times 10^{24}}{(6.4 \times 10^6)^2} \text{ N} = 733 \text{ N}$$



**Use your brain power !**

Thus, if the earth attracts an apple towards itself, the apple also attracts the earth towards itself with the same force. Why then does the apple fall towards the earth, but the earth does not move towards the apple?

The gravitational force due to the earth also acts on the moon because of which it revolves around the earth. Similar situation exists for the artificial satellites orbiting the earth. The moon and the artificial satellites orbit the earth. The earth attracts them towards itself but unlike the falling apple, they do not fall on the earth, why? This is because of the velocity of the moon and the satellites along their orbits. If this velocity was not there, they would have fallen on the earth.

**Example 2:** Starting from rest, what will be Mahendra's velocity after one second if he is falling down due to the gravitational force of the earth?

**Given:**  $u = 0$ ,  $F = 733$  N,  
 Mahendra's mass =  $m = 75$  kg  
 time  $t = 1$  s

Mahendra's acceleration

$$a = \frac{F}{m} = \frac{733}{75} \text{ m/s}^2$$

According to Newton's first equation of motion,

$$v = u + a t$$

Mahendra's velocity after 1 second

$$v = 0 + 9.77 \times 1 \text{ m/s}$$

$$v = 9.77 \text{ m/s}$$

This is  $1.83 \times 10^9$  times Mahendra's velocity in example 2, on page 6.

According to Newton's law of gravitation, every object attracts every other object.

## Earth's gravitational acceleration

The earth exerts gravitational force on objects near it. According to Newton's second law of motion, a force acting on a body results in its acceleration. Thus, the gravitational force due to the earth on a body results in its acceleration. This is called acceleration due to gravity and is denoted by 'g'. Acceleration is a vector. As the gravitational force on any object due to the earth is directed towards the centre of the earth, the direction of the acceleration due to gravity is also directed towards the centre of the earth i.e. vertically downwards.



### Think about it

1. What would happen if there were no gravity?
2. What would happen if the value of G was twice as large?

### Value of g on the surface of the earth

We can calculate the value of g by using Newton's universal law of gravitation for an object of mass m situated at a distance r from the centre of the earth. The law of gravitation gives

$$F = \frac{G M m}{r^2} \dots\dots\dots (3) \quad M \text{ is the mass of the earth.}$$

$$F = m g \dots\dots\dots (4) \quad \text{From (3) and (4), } mg = \frac{G M m}{r^2}$$

$$g = \frac{G M}{r^2} \dots\dots\dots (5) \quad \text{If the object is situated on the surface of the earth, } r = R = \text{Radius of the earth. Thus, the value of g on the surface of the earth is.}$$

$$g = \frac{G M}{R^2} \dots\dots\dots (6) \quad \text{The unit of g in SI units is m/s}^2 \text{ The mass and radius of the earth are } 6 \times 10^{24} \text{ kg and } 6.4 \times 10^6 \text{ m, respectively. Using these in (6)}$$

$$g = \frac{6.67 \times 10^{-11} \times 6 \times 10^{24}}{(6.4 \times 10^6)^2} = 9.77 \text{ m/s}^2 \dots\dots\dots (7)$$

This acceleration depends only on the mass M and radius R of the earth and so the acceleration due to gravity at a given point on the earth is the same for all objects. It does not depend on the properties of the object.



### Can you tell?

What would be the value of g on the surface of the earth if its mass was twice as large and its radius half of what it is now?

### Variation in value of g

**A. Change along the surface of the earth :** Will the value of g be the same everywhere on the surface of the earth? The answer is no. The reason is that the shape of the earth is not exactly spherical and so the distance of a point on the surface of the earth from its centre differs somewhat from place to place. Due to its rotation, the earth bulges at the equator and is flatter at the poles. Its radius is largest at the equator and smallest at the poles. The value of g is thus highest (9.832 m/s<sup>2</sup>) at the poles and decreases slowly with decreasing latitude. It is lowest (9.78 m/s<sup>2</sup>) at the equator.

**B. Change with height :** As we go above the earth's surface, the value of r in equation (5) increases and the value of g decreases. However, the decrease is rather small for heights which are small in comparison to the earth's radius. For example, remember that the radius of the earth is 6400 km. If an aeroplane is flying at a height 10 km above the surface of the earth, its distance from the earth's surface changes from 6400 km to 6410 km and the change in the value of g due to it is negligible. On the other hand, when we consider an artificial satellite orbiting the earth, we have to take into account the change in the value of g due to the large change in the distance of the satellite from the centre of the earth. Some typical heights and the values of g at these heights are given in the following table.

Place	Height (km)	g (m/s <sup>2</sup> )
Surface of the earth (average)	0	9.8
Mount Everest	8.8	9.8
Maximum height reached by man-made balloon	36.6	9.77
Height of a typical weather satellite	400	8.7
Height of communication satellite	35700	0.225

### 1.7 Table showing change of g with height above the earth's surface

**C. Change with depth :** The value of g also changes if we go inside the earth. The value of r in equation (5) decreases and one would think that the value of g should increase as per the formula. However, the part of the earth which contributes towards the gravitational force felt by the object also decreases. Which means that the value of M to be used in equation (5) also decreases. As a combined result of change in r and M, the value of g decreases as we go deep inside the earth.



#### Think about it

1. Will the direction of the gravitational force change as we go inside the earth?
2. What will be the value of g at the centre of the earth?

Every planet and satellite has different mass and radius. Hence, according to equation (6), the values of g on their surfaces are different. On the moon it is about 1/6<sup>th</sup> of the value on the earth. As a result, using the same amount of force, we can jump 6 times higher on the moon as compared to that on the earth.

### Mass and Weight

**Mass :** Mass is the amount of matter present in the object. The SI unit of mass is kg. Mass is a scalar quantity. Its value is same everywhere. Its value does not change even when we go to another planet. According to Newton's first law, it is the measure of the inertia of an object. Higher the mass, higher is the inertia.

**Weight :** The weight of an object is defined as the force with which the earth attracts the object. The force (F) on an object of mass m on the surface of the earth can be written using equation (4)

$$\therefore \text{Weight, } W = F = m g \quad \dots \left( g = \frac{G M}{R^2} \right)$$

Weight being a force, its SI unit is Newton. Also, the weight, being a force, is a vector quantity and its direction is towards the centre of the earth. As the value of g is not same everywhere, the weight of an object changes from place to place, though its mass is constant everywhere.

Colloquially we use weight for both mass and weight and measure the weight in kilograms which is the unit of mass. But in scientific language when we say that Rajeev's weight is 75 kg, we are talking about Rajeev's mass. What we mean is that Rajeev's weight is equal to the gravitational force on 75 kg mass. As Rajeev's mass is 75 kg, his weight on earth is  $F = mg = 75 \times 9.8 = 735 \text{ N}$ . The weight of 1 kg mass is  $1 \times 9.8 = 9.8 \text{ N}$ . Our weighing machines tell us the mass. The two scale balances in shops compare two weights i.e. two masses.





**Use your brain power !**

1. Will your weight remain constant as you go above the surface of the earth?
2. Suppose you are standing on a tall ladder. If your distance from the centre of the earth is  $2R$ , what will be your weight?

**Solved Examples**

**Example 1:** If a person weighs 750 N on earth, how much would be his weight on the Moon given that moon’s mass is  $\frac{1}{81}$  of that of the earth and its radius is  $\frac{1}{3.7}$  of that of the earth ?

**Given:** Weight on earth = 750 N,

Ratio of mass of the earth ( $M_E$ ) to mass of the moon ( $M_M$ ) =  $\frac{M_E}{M_M} = 81$

Ratio of radius of earth ( $R_E$ ) to radius of moon ( $R_M$ ) =  $\frac{R_E}{R_M} = 3.7$

Let the mass of the person be  $m$  kg

Weight on the earth =  $m g = 750 = \frac{m G M_E}{R_E^2} \quad \therefore m = \frac{750 R_E^2}{(G M_E)} \dots\dots\dots (i)$

Weight on Moon =  $\frac{m G M_M}{R_M^2}$  using (i)

$= \frac{750 R_E^2}{(G M_E)} \times \frac{G M_M}{R_M^2} = 750 \frac{R_E^2}{R_M^2} \times \frac{M_M}{M_E} = 750 \times (3.7)^2 \times \frac{1}{81} = 126.8 \text{ N}$

The weight on the moon is nearly  $1/6^{\text{th}}$  of the weight on the earth. We can write the weight on moon as  $m g_m$  ( $g_m$  is the acceleration due to gravity on the moon). Thus  $g_m$  is  $1/6^{\text{th}}$  of the  $g$  on the earth.



**Do you know ?**

**Gravitational waves**

Waves are created on the surface of water when we drop a stone into it. Similarly you must have seen the waves generated on a string when both its ends are held in hand and it is shaken. Light is also a type of wave called the electromagnetic wave. Gamma rays, X-rays, ultraviolet rays, infrared rays, microwave and radio waves are all different types of electromagnetic waves. Astronomical objects emit these waves and we receive them using our instruments. All our knowledge about the universe has been obtained through these waves.

Gravitational waves are a very different type of waves. They have been called the waves on the fabric of space-time. Einstein predicted their existence in 1916. These waves are very weak and it is very difficult to detect them. Scientists have constructed extremely sensitive instruments to detect the gravitational waves emitted by astronomical sources. Among these, LIGO (Laser Interferometric Gravitational Wave Observatory) is the prominent one. Exactly after hundred years of their prediction, scientists detected these waves coming from an astronomical source. Indian scientists have contributed significantly in this discovery. This discovery has opened a new path to obtain information about the Universe.

## Free fall



### Try this

Take a small stone. Hold it in your hand. Which forces are acting on the stone? Now release the stone. What do you observe? What are the forces acting on the stone after you release it?

We know that the force of gravity due to the earth acts on each and every object. When we were holding the stone in our hand, the stone was experiencing this force, but it was balanced by a force that we were applying on it in the opposite direction. As a result, the stone remained at rest. Once we release the stone from our hands, the only force that acts on it is the gravitational force of the earth and the stone falls down under its influence. Whenever an object moves under the influence of the force of gravity alone, it is said to be falling freely. Thus the released stone is in a free fall. In free fall, the initial velocity of the object is zero and goes on increasing due to the acceleration due to gravity of the earth. During free fall, the frictional force due to air opposes the motion of the object and a buoyant force also acts on the object. Thus, true free fall is possible only in vacuum.

For a freely falling object, the velocity on reaching the earth and the time taken for it can be calculated by using Newton's equations of motion. For free fall, the initial velocity  $u = 0$  and the acceleration  $a = g$ . Thus we can write the equations as

$$v = g t$$

$$s = \frac{1}{2} g t^2$$

$$v^2 = 2 g s$$

For calculating the motion of an object thrown upwards, acceleration is negative, i.e. in a direction opposite to the velocity and is taken to be  $-g$ . The magnitude of  $g$  is the same but the velocity of the object decreases because of this -ve acceleration.

The moon and the artificial satellites are moving only under the influence of the gravitational field of the earth. Thus they are in free fall.



### Do you know ?

The value of  $g$  is the same for all objects at a given place on the earth. Thus, any two objects, irrespective of their masses or any other properties, when dropped from the same height and falling freely will reach the earth at the same time. Galileo is said to have performed an experiment around 1590 in the Italian city of Pisa. He dropped two spheres of different masses from the leaning tower of Pisa to demonstrate that both spheres reached the ground at the same time.

When we drop a feather and a heavy stone at the same time from a height, they do not reach the earth at the same time. The feather experiences a buoyant force and a frictional force due to air and therefore floats and reaches the ground slowly, later than the heavy stone. The buoyant and frictional forces on the stone are much less than the weight of the stone and does not affect the speed of the stone much. Recently, scientists performed this experiment in vacuum and showed that the feather and stone indeed reach the earth at the same time.

<https://www.youtube.com/watch?v=eRNC5kevINA>

## Solved Examples

**Example 1.** An iron ball of mass 3 kg is released from a height of 125 m and falls freely to the ground. Assuming that the value of  $g$  is  $10 \text{ m/s}^2$ , calculate

- (i) time taken by the ball to reach the ground
- (ii) velocity of the ball on reaching the ground
- (iii) the height of the ball at half the time it takes to reach the ground.

**Given:**  $m = 3 \text{ kg}$ , distance travelled by the ball  $s = 125 \text{ m}$ , initial velocity of the ball  $= u = 0$  and acceleration  $a = g = 10 \text{ m/s}^2$ .

(i) Newton's second equation of motion gives

$$s = u t + \frac{1}{2} a t^2$$

$$\therefore 125 = 0 t + \frac{1}{2} \times 10 \times t^2 = 5 t^2$$

$$t^2 = \frac{125}{5} = 25, \quad t = 5 \text{ s}$$

The ball takes 5 seconds to reach the ground.

(ii) According to Newton's first equation of motion final velocity  $= v = u + a t$

$$= 0 + 10 \times 5 \\ = 50 \text{ m/s}$$

The velocity of the ball on reaching the ground is 50 m/s

(iii) Half time  $= t = \frac{5}{2} = 2.5 \text{ s}$

Ball's height at this time  $= s$

According to Newton's second equation

$$s = u t + \frac{1}{2} a t^2$$

$$s = 0 + \frac{1}{2} \times 10 \times (2.5)^2 = 31.25 \text{ m.}$$

Thus the height of the ball at half time  $= 125 - 31.25 = 93.75 \text{ m}$

**Example 2.** A tennis ball is thrown up and reaches a height of 4.05 m before coming down. What was its initial velocity? How much total time will it take to come down?

Assume  $g = 10 \text{ m/s}^2$

**Given:** For the upward motion of the ball, the final velocity of the ball  $= v = 0$

Distance travelled by the ball  $= 4.05 \text{ m}$

acceleration  $a = -g = -10 \text{ m/s}^2$

Using Newton's third equation of motion

$$v^2 = u^2 + 2 a s$$

$$0 = u^2 + 2 (-10) \times 4.05$$

$$\therefore u^2 = 81$$

$u = 9 \text{ m/s}$  The initial velocity of the ball is 9 m/s

Now let us consider the downward motion of the ball. Suppose the ball takes  $t$  seconds to come down. Now the initial velocity of the ball is zero,  $u = 0$ . Distance travelled by the ball on reaching the ground  $= 4.05 \text{ m}$ . As the velocity and acceleration are in the same direction,

$a = g = 10 \text{ m/s}^2$

According to Newton's second equation of motion

$$s = u t + \frac{1}{2} a t^2$$

$$4.05 = 0 + \frac{1}{2} \times 10 t^2$$

$$t^2 = \frac{4.05}{5} = 0.81, \quad t = 0.9 \text{ s}$$

The ball will take 0.9 s to reach the ground. It will take the same time to go up. Thus, the total time taken  $= 2 \times 0.9 = 1.8 \text{ s}$



Use your brain power !

According to Newton's law of gravitation, earth's gravitational force is higher on an object of larger mass. Why doesn't that object fall down with higher velocity as compared to an object with lower mass?



## Gravitational potential energy

We have studied potential energy in last standard. The energy stored in an object because of its position or state is called potential energy. This energy is relative and increases as we go to greater heights from the surface of the earth. We had assumed that the potential energy of an object of mass  $m$ , at a height  $h$  from the ground is  $mgh$  and on the ground it is zero. When  $h$  is small compared to the radius  $R$  of the earth, we can assume  $g$  to be constant and can use the above formula ( $mgh$ ). But for large values of  $h$ , the value of  $g$  decreases with increase in  $h$ . For an object at infinite distance from the earth, the value of  $g$  is zero and earth's gravitational force does not act on the object. So it is more appropriate to assume the value of potential energy to be zero there. Thus, for smaller distances, i.e. heights, the potential energy is less than zero, i.e. it is negative.

When an object is at a height  $h$  from the surface of the earth, its potential energy is  $-\frac{GMm}{R+h}$

here,  $M$  and  $R$  are earth's mass and radius respectively.

## Escape velocity

We have seen that when a ball is thrown upwards, its velocity decreases because of the gravitation of the earth. The velocity becomes zero after reaching a certain height and after that the ball starts falling down. Its maximum height depends on its initial velocity. According to Newton's third equation of motion is

$$v^2 = u^2 + 2as,$$

$v$  = the final velocity of the ball = 0 and  $a = -g$

$$\therefore 0 = u^2 + 2(-g)s \text{ and maximum height of the ball} = s = -\frac{u^2}{2g}$$

Thus, higher the initial velocity  $u$ , the larger is the height reached by the ball.

The reason for this is that the higher the initial velocity, the ball will oppose the gravity of the earth more and larger will be the height to which it can reach.

We have seen above that the value of  $g$  keeps decreasing as we go higher above the surface of the earth. Thus, the force pulling the ball downward, decreases as the ball goes up. If we keep increasing the initial velocity of the ball, it will reach larger and larger heights and above a particular value of initial velocity of the ball, the ball is able to overcome the downward pull by the earth and can escape the earth forever and will not fall back on the earth. This velocity is called escape velocity. We can determine its value by using the law of conservation of energy as follows.

An object going vertically upwards from the surface of the earth, having an initial velocity equal to the escape velocity, escapes the gravitational force of the earth. The force of gravity, being inversely proportional to the square of the distance, becomes zero only at infinite distance from the earth. This means that for the object to be free from the gravity of the earth, it has to reach infinite distance from the earth. i.e. the object will come to rest at infinite distance and will stay there.

### For an object of mass $m$

on the surface of earth

A. Kinetic energy =  $\frac{1}{2} mv_{\text{esc}}^2$

B. Potential energy =  $-\frac{GMm}{R}$

C. Total energy =  $E_1 = \text{Kinetic energy} + \text{Potential energy}$

$$= \frac{1}{2} mv_{\text{esc}}^2 - \frac{GMm}{R}$$

at infinite distance from the earth

A. Kinetic energy = 0

B. Potential energy =  $-\frac{GMm}{\infty} = 0$

C. Total energy =  $E_2 = \text{Kinetic energy} + \text{potential energy} = 0$

From the principle of conservation of energy

$$E_1 = E_2$$

$$\frac{1}{2} mv_{\text{esc}}^2 - \frac{GMm}{R} = 0$$

$$v_{\text{esc}}^2 = \frac{2GM}{R}$$

$$v_{\text{esc}} = \sqrt{\frac{2GM}{R}}$$

$$= \sqrt{2gR}$$

$$= \sqrt{(2 \times 9.8 \times 6.4 \times 10^6)} = 11.2 \text{ km/s}$$

The spacecrafts which are sent to the moon or other planets have to have their initial velocity larger than the escape velocity so that they can overcome earth's gravitational attraction and can travel to these objects.

### Solved Examples

**Example 1.** Calculate the escape velocity on the surface of the moon given the mass and radius of the moon to be  $7.34 \times 10^{22}$  kg and  $1.74 \times 10^6$  m respectively.

**Given:**  $G = 6.67 \times 10^{-11} \text{ N m}^2/\text{kg}^2$ , mass of the moon =  $M = 7.34 \times 10^{22}$  kg and radius of the moon =  $R = 1.74 \times 10^6$  m.

$$\text{Escape velocity} = v_{\text{esc}} = \sqrt{\frac{2GM}{R}}$$

$$= \sqrt{\frac{2 \times 6.67 \times 10^{-11} \times 7.34 \times 10^{22}}{1.74 \times 10^6}}$$

$$= 2.37 \text{ km/s}$$

Escape velocity on the moon 2.37 km/s.



### Do you know ?

#### Weightlessness in space

Space travellers as well as objects in the spacecraft appear to be floating. Why does this happen? Though the spacecraft is at a height from the surface of the earth, the value of  $g$  there is not zero. In the space station the value of  $g$  is only 11% less than its value on the surface of the earth. Thus, the height of a spacecraft is not the reason for their weightlessness. Their weightlessness is caused by their being in the state of free fall. Though the spacecraft is not falling on the earth because of its velocity along the orbit, the only force acting on it is the gravitational force of the earth and therefore it is in a free fall. As the velocity of free fall does not depend on the properties of an object, the velocity of free fall is the same for the spacecraft, the travelers and the objects in the craft. Thus, if a traveller releases an object from her hand, it will remain stationary with respect to her and will appear to be weightless.

### Exercise

1. Study the entries in the following table and rewrite them putting the connected items in a single row.

I	II	III
Mass	$\text{m/s}^2$	Zero at the centre
Weight	kg	Measure of inertia
Acceleration due to gravity	$\text{Nm}^2/\text{kg}^2$	Same in the entire universe
Gravitational constant	N	Depends on height

2. Answer the following questions.

- What is the difference between mass and weight of an object. Will the mass and weight of an object on the earth be same as their values on Mars? Why?
- What are (i) free fall, (ii) acceleration due to gravity (iii) escape velocity (iv) centripetal force ?
- Write the three laws given by Kepler. How did they help Newton to arrive at the inverse square law of gravity?

- d. A stone thrown vertically upwards with initial velocity  $u$  reaches a height 'h' before coming down. Show that the time taken to go up is same as the time taken to come down.
- e. If the value of  $g$  suddenly becomes twice its value, it will become two times more difficult to pull a heavy object along the floor. Why?

**3. Explain why the value of  $g$  is zero at the centre of the earth.**

**4. Let the period of revolution of a planet at a distance  $R$  from a star be  $T$ . Prove that if it was at a distance of  $2R$  from the star, its period of revolution will be  $\sqrt{8} T$ .**

**5. Solve the following examples.**

- a. An object takes 5 s to reach the ground from a height of 5 m on a planet. What is the value of  $g$  on the planet?

**Ans: 0.4 m/s<sup>2</sup>**

- b. The radius of planet A is half the radius of planet B. If the mass of A is  $M_A$ , what must be the mass of B so that the value of  $g$  on B is half that of its value on A?

**Ans:  $2 M_A$**

- c. The mass and weight of an object on earth are 5 kg and 49 N respectively. What will be their values on the moon? Assume that the acceleration due to gravity on the moon is 1/6th of that on the earth.

**Ans: 5 kg and 8.17 N**

- d. An object thrown vertically upwards reaches a height of 500 m. What was its initial velocity? How long will the object take to come back to the earth? Assume  $g = 10 \text{ m/s}^2$

**Ans: 100 m/s and 20 s**

- e. A ball falls off a table and reaches the ground in 1 s. Assuming  $g = 10 \text{ m/s}^2$ , calculate its speed on reaching the ground and the height of the table.

**Ans. 10 m/s and 5 m**

- f. The masses of the earth and moon are  $6 \times 10^{24} \text{ kg}$  and  $7.4 \times 10^{22} \text{ kg}$ , respectively. The distance between them is  $3.84 \times 10^5 \text{ km}$ . Calculate the gravitational force of attraction between the two?

Use  $G = 6.7 \times 10^{-11} \text{ N m}^2 \text{ kg}^{-2}$

**Ans:  $2 \times 10^{20} \text{ N}$**

- g. The mass of the earth is  $6 \times 10^{24} \text{ kg}$ . The distance between the earth and the Sun is  $1.5 \times 10^{11} \text{ m}$ . If the gravitational force between the two is  $3.5 \times 10^{22} \text{ N}$ , what is the mass of the Sun?

Use  $G = 6.7 \times 10^{-11} \text{ N m}^2 \text{ kg}^{-2}$

**Ans:  $1.96 \times 10^{30} \text{ kg}$**

**Project:**

Take weights of five of your friends. Find out what their weights will be on the moon and the Mars.



## 2.Periodic Classification of Elements



- Elements and their classification
- Newlands Law of Octaves
- Modern Periodic Table
- Dobereiner's Triads
- Mendeleev's Periodic Table



Can you recall?

1. What are the types of matter?
2. What are the types of elements?
3. What are the smallest particles of matter called?
4. What is the difference between the molecules of elements and compounds?

### Classification of elements

We have learnt in the previous standards that all the atoms of an element are of only one type. Today 118 elements are known to the scientific world. However, around year 1800 only about 30 elements were known. More number of elements were discovered in the course of time. More and more information about the properties of these elements was gathered. To ease the study of such a large number of elements, scientists started studying the pattern if any, in the vast information about them. You know that in the initial classification elements were classified into the groups of metals and nonmetals. Later on another class of elements called metalloids was noticed. As the knowledge about elements and their properties went on increasing different scientists started trying out different methods of classification.

### Dobereiner's Triads

In the year 1817 a German scientist Dobereiner suggested that properties of elements are related to their atomic masses. He made groups of three elements each, having similar chemical properties and called them triads. He arranged the three elements in a triad in an increasing order of atomic mass and showed that the atomic mass of the middle element was approximately equal to the mean of the atomic masses of the other two elements. However, all the known elements could not be classified into the Dobereiner's triads.

Sr. No.	Triad	Element - 1 Actual atomic mass(a)	Element - 2		Element - 3 Actual atomic mass (c)
			Mean = $\frac{a+c}{2}$	Actual atomic mass	
1	Li, Na, K	Lithium (Li) 6.9	Sodium $\frac{6.9 + 39.1}{2} = 23.0$	(Na) 23.0	Potassium (K) 39.1
2	Ca, Sr, Ba	Calcium (Ca) 40.1	Strontium $\frac{40.1 + 137.3}{2} = 88.7$	(Sr) 87.6	Barium (Ba) 137.3
3	Cl, Br, I	Chlorine (Cl) 35.5	Bromine $\frac{35.5 + 126.9}{2} = 81.2$	(Br) 79.9	Iodine (I) 126.9

### 2.1 Dobereiner's Triads



Can you tell?

Identify Dobereiner's triads from the following groups of elements having similar chemical properties.

1. Mg (24.3), Ca (40.1), Sr (87.6)
2. S (32.1), Se (79.0), Te (127.6)
3. Be (9.0), Mg (24.3), Ca (40.1)



## Newlands' Law of Octaves

The English scientist John Newlands correlated the atomic masses of elements to their properties in a different way. In the year 1866 Newlands arranged the elements known at that time in an increasing order of their atomic masses. It started with the lightest element hydrogen and ended up with thorium. He found that every eighth element had properties similar to those of the first. For example, sodium is the eighth element from lithium and both have similar properties. Also, magnesium shows similarity to beryllium and chlorine shows similarity with fluorine. Newlands compared this similarity with the octaves in music. He called the similarity observed in the eighth and the first element as the **Law of octaves**.



### Do you know ?

In the Indian music system there are seven main notes, namely, Sa, Re, Ga, Ma, Pa, Dha, Ni, and their collection is called 'Saptak'. The frequency of the notes goes on increasing from 'Sa' to 'Ni'. Then comes, the 'Sa' of the upper 'Saptak' at the double the frequency of the original 'Sa'. It means that notes repeat after completion of one 'Saptak'. The seven notes in the western music are Do, Re, Mi, Fa, So, La, Ti.

The note 'Do' having double the original frequency comes again at the eighth place. This is the octave of western notes. Music is created by the variety in the use of these notes.

Musical Note	Do (Sa)	Re (Re)	Mi (Ga)	Fa (Ma)	So (Pa)	La (Dha)	Ti (Ni)
Elements	H	Li	Be	B	C	N	O
	F	Na	Mg	Al	Si	P	S
	Cl	K	Ca	Cr	Ti	Mn	Fe
	Co & Ni	Cu	Zn	Y	In	As	Se
	Br	Rb	Sr	Ce & La	Zr		

## 2.2 Newlands' Octaves

Many limitations were found in Newlands' octaves. This law was found to be applicable only up to calcium. Newlands fitted all the known elements in a table of 7 X 8 that is 56 boxes. Newlands placed two elements each in some boxes to accommodate all the known elements in the table. For example, Co and Ni, Ce and La. Moreover, he placed some elements with different properties under the same note in the octave. For example, Newlands placed the metals Co and Ni under the note 'Do' along with halogens, while Fe, having similarity with Co and Ni, away from them along with the nonmetals O and S under the note 'Ti'. Also, Newlands' octaves did not have provision to accommodate the newly discovered elements. The properties of the new elements discovered later on did not fit in the Newlands' law of octaves.

## Mendeleev's Periodic table

The Russian scientist Dmitri Mendeleev developed the periodic table of elements during the period 1869 to 1872 A.D. Mendeleev's periodic table is the most important step in the classification of elements. Mendeleev considered the fundamental property of elements, namely, the atomic mass, as standard and arranged 63 elements known at that time in an increasing order of their atomic masses. Then he transformed this into the periodic table of elements in accordance with the physical and chemical properties of these elements.

Mendeleev organized the periodic table on the basis of the chemical and physical properties of the elements. These were the molecular formulae of hydrides and oxides of the elements, melting points, boiling points and densities of the elements and their hydrides and oxides. Mendeleev found that the elements with similar physical and chemical properties repeat after a definite interval. **On the basis of this finding Mendeleev stated the following periodic law.**

**Properties of elements are periodic function of their atomic masses.**

The vertical columns in the Mendeleev's periodic table are called groups while the horizontal rows are called periods.

Se- ries ↓	Group I - R <sup>2</sup> O	Group II - RO	Group III - R <sup>2</sup> O <sup>3</sup>	Group IV RH <sup>4</sup> RO <sup>2</sup>	Group V RH <sup>3</sup> R <sup>2</sup> O <sup>5</sup>	Group VI RH <sup>2</sup> RO <sup>3</sup>	Group VII RH R <sup>2</sup> O <sup>7</sup>	Group VIII - RO <sup>4</sup>
1	H=1							
2	Li=7	Be=9.4	B=11	C=12	N=14	O=16	F=19	
3	Na=23	Mg=24	Al=27.3	Si=28	P=31	S=32	Cl= 35.5	
4	K=39	Ca=40	- = 44	Ti= 48	V=51	Cr= 52	Mn=55	Fe=56, Co=59 Ni=59, Cu=63
5	(Cu=63)	Zn=65	--68	--72	As=75	Se=78	Br=80	
6	Rb=85	Sr=87	?Yt=88	Zr=90	Nb=94	Mo=96	--=100	Ru=104,Rh=104 Pd=106,Ag=108
7	(Ag=108)	Cd=112	In=113	Sn=118	Sb=122	Te=125	J=127	
8	Cs=133	Ba=137	?Di=138	?Ce=140	-	-	-	----
9	(-)	-	-	-	-	-	-	
10	-	-	?Er=178	?La=180	Ta=182	W=184	-	Os=195, Ir=197 Pt=198, Au=199
11	(Au=199)	Hg=200	Ti=204	Pb=207	Bi= 208	-	-	
12	-	-	-	Th=231	-	U=240	-	---

### 2.3 Mendeleev's Periodic Table

(The general molecular formulae of compounds shown as R<sup>2</sup>O, R<sup>2</sup>O<sup>3</sup>, etc. in the upper part of Mendeleev's periodic table, are written as R<sub>2</sub>O, R<sub>2</sub>O<sub>3</sub>, etc. in the present system.)



Dmitri Mendeleev

#### Introduction to scientist

Dmitri Mendeleev (1834-1907) was a professor in the St. Petersburg University. He made separate card for every known element showing its atomic mass. He arranged the cards in accordance with the atomic masses and properties of the elements which resulted in the invention of the periodic table of elements.



### Think about it

1. There are some vacant places in the Mendeleev's periodic table. In some of these places the atomic masses are seen to be predicted. Enlist three of these predicted atomic masses along with their group and period.
2. Due to uncertainty in the names of some of the elements, a question mark is indicated before the symbol in the Mendeleev's periodic table. What are such symbols?

### Merits of Mendeleev's periodic table

Science is progressive. There is a freedom in science to revise the old inference by using more advanced means and methods of doing experiments. These characteristics of science are clearly seen in the Mendeleev's periodic table.

While applying the law that the properties of elements are a periodic function of their atomic masses, to all the known elements, Mendeleev arranged the elements with a thought that the information available till then was not final but it could change. As a result of this, Mendeleev's periodic table demonstrates the following merits.

1. Atomic masses of some elements were revised so as to give them proper place in the periodic table in accordance with their properties. For example, the previously determined atomic mass of beryllium, 14.09, was changed to the correct value 9.4, and beryllium was placed before boron.
2. Mendeleev kept vacant places in the periodic table for elements not discovered till then. Three of these unknown elements were given the names eka-boron, eka-aluminum and eka-silicon from the known neighbours and their atomic masses were indicated as 44, 68 and 72, respectively. Not only this but their properties were also predicted. Later on these elements were discovered and named as scandium (Sc), gallium (Ga) and germanium (Ge) respectively. The properties of these elements matched well with those predicted by Mendeleev. See table 2.4. Due to this success all were convinced about the importance of Mendeleev's periodic table and this method of classification of elements was accepted immediately.

Property	eka- aluminum(E) (Mendeleev's prediction)	Gallium (Ga)(actual)
1. Atomic mass	68	69.7
2. Density (g/cm <sup>3</sup> )	5.9	5.94
3. Melting point( <sup>0</sup> C)	Low	30.2
4. Formula of chloride	ECl <sub>3</sub>	GaCl <sub>3</sub>
5. Formula of oxide	E <sub>2</sub> O <sub>3</sub>	Ga <sub>2</sub> O <sub>3</sub>
6. Nature of oxide	Amphoteric oxide	Amphoteric oxide

### 2.4 Actual and predicted properties of gallium.

3. There was no place reserved for noble gases in Mendeleev's original periodic table. However, when noble gases such as helium, neon and argon were discovered towards the end of nineteenth century, Mendeleev created the 'zero' group without disturbing the original periodic table in which the noble gases were fitted very well.



### Use your brain power !

Chlorine has two isotopes, viz, C1-35 and C1-37. Their atomic masses are 35 and 37 respectively. Their chemical properties are same. Where should these be placed in Mendeleev's periodic table? In different places or in the same place?

## Demerits of Mendeleev's periodic table

1. The whole number atomic mass of the elements cobalt (Co) and nickel (Ni) is the same. Therefore there was an ambiguity regarding their sequence in Mendeleev's periodic table.
2. Isotopes were discovered long time after Mendeleev put forth the periodic table. As isotopes have the same chemical properties but different atomic masses, a challenge was posed in placing them in Mendeleev's periodic table.
3. When elements are arranged in an increasing order of atomic masses, the rise in atomic mass does not appear to be uniform. It was not possible, therefore, to predict how many elements could be discovered between two heavy elements.
4. Position of hydrogen : Hydrogen shows similarity with halogens (group VII). For example, the molecular formula of hydrogen is  $H_2$  while the molecular formulae of fluorine and chlorine are  $F_2$  and  $Cl_2$ , respectively. In the same way, there is a similarity in the chemical properties of hydrogen and alkali metals (group I). There is a similarity in the molecular formulae of the compounds of hydrogen alkali metals (Na, K, etc.) formed with chlorine and oxygen. On considering the above properties it can not be decided whether the correct position of hydrogen is in the group of alkali metals (group I) or in the group of halogens (group VII).

Compounds of H	Compounds of Na
HCl	NaCl
$H_2O$	$Na_2O$
$H_2S$	$Na_2S$

## 2.5 Similarity in hydrogen and alkali metals

Element (Molecular formula)	Compounds with metals	Compounds with nonmetals
$H_2$	NaH	$CH_4$
$Cl_2$	NaCl	$CCl_4$

## 2.6 : Similarity in hydrogen and halogens



### Use your brain power !

1. Write the molecular formulae of oxides of the following elements by referring to the Mendeleev's periodic table. Na, Si, Ca, C, Rb, P, Ba, Cl, Sn.
2. Write the molecular formulae of the compounds of the following elements with hydrogen by referring to the Mendeleev's periodic table. C, S, Br, As, F, O, N, Cl

## Modern Periodic Law

The scientific world did not know anything about the interior of the atom when Mendeleev put forth the periodic table. After the discovery of electron, scientists started exploring the relation between the electron number of an atom and the atomic number. The atomic number in Mendeleev's periodic table only indicated the serial number of the element.

In 1913 A.D. the English scientist Henry Moseley demonstrated, with the help of the experiments done using X-ray tube, that the atomic number ( $Z$ ) of an element corresponds to the positive charge on the nucleus or the number of the protons in the nucleus of the atom of that element. This revealed that 'atomic number' is a more fundamental property of an element than its atomic mass. Accordingly the statement of the modern periodic law was stated as follows:

**Properties of elements are a periodic function of their atomic numbers.**



## Modern periodic table : long form of the periodic table

The classification of elements resulting from an arrangement of the elements in an increasing order of their atomic numbers is the modern periodic table. The properties of elements can be predicted more accurately with the help of the modern periodic table formed on the basis of atomic numbers. The modern periodic table is also called the long form of the periodic table.

In the modern periodic table the elements are arranged in accordance with their atomic number. (see table 2.7) As a result, most of the drawbacks of Mendeleev's periodic table appear to be removed. However, the ambiguity about the position of hydrogen is not removed even in the modern periodic table.

We have seen in the previous standard that the electronic configuration of an atom, the way in which the electron are distributed in the shells around the nucleus, is determined by the total number of electrons in it; and the total number of electrons in an atom is same as the atomic number. The relation between the atomic number of an element and its electronic configuration is clearly seen in the modern periodic table.

### Structure of the Modern Periodic Table

The modern periodic table contains seven horizontal rows called the periods 1 to 7. Similarly, the eighteen vertical columns in this table are the groups 1 to 18. The arrangement of the periods and groups results into formation of boxes. Atomic numbers are serially indicated in the upper part of these boxes. Each box corresponds to the place for one element.

Apart from these seven rows, two rows are shown separately at the bottom of the periodic table. These are called lanthanide series and actinide series, respectively. There are 118 boxes in the periodic table including the two series. It means that there are 118 places for elements in the modern periodic table. Very recently formation of a few elements was established experimentally and thereby the modern periodic table is now completely filled. All the 118 elements are now discovered.

The entire periodic table is divided into four blocks, viz, s-block, p-block, d-block and f-block. The s-block contains the groups 1 and 2. The groups 13 to 18 constitute the p-block. The groups 3 to 12 constitute the d-block, while the lanthanide and actinide series at the bottom form the f-block. The d-block elements are called transition elements. A zig-zag line can be drawn in the p-block of the periodic table. The three traditional types of elements can be clearly shown in the modern periodic table with the help of this zig-zag line. The metalloid elements lie along the border of this zig-zag line. All the metals lie on the left side of the zig-zag line while all the nonmetals lie on the right side.



Use your brain power !

### Position of the elements in the periodic elements.....

1. How is the problem regarding the position of cobalt ( $^{59}\text{Co}$ ) and nickel ( $^{59}\text{Ni}$ ) in Mendeleev's periodic table resolved in modern periodic table?
2. How did the position of  $^{35}_{17}\text{Cl}$  and  $^{37}_{17}\text{Cl}$  get fixed in the modern periodic table?
3. Can there be an element with atomic mass 53 or 54 in between the two elements, chromium  $^{52}_{24}\text{Cr}$  and manganese  $^{55}_{25}\text{Mn}$  ?
4. What do you think? Should hydrogen be placed in the group 17 of halogens or group 1 of alkali metals in the modern periodic table?

## Modern periodic Table and electronic Configuration of Elements

Within a period the neighbouring elements differ slightly in their properties while distant elements differ widely in their properties. Elements in the same group show similarity and gradation in their properties. These characteristics of the groups and periods in the modern periodic table are because of the electronic configuration of the elements. It is the electronic configuration of an element which decides the group and the period in which it is to be placed.

### Characteristics of Groups and Periods

The characteristics of the groups and periods in the periodic table are understood by comparison of the properties of the elements. Various properties of all the elements in a group show similarity and gradation. However, the properties of elements change slowly while going from one end to the other (for example, from left to right) in a particular period.

### Groups and electronic configuration



**Can you tell?**

1. Go through the modern periodic table (table no. 2.7) and write the names one below the other of the elements of group 1.
2. Write the electronic configuration of the first four elements in this group.
3. Which similarity do you find in their configuration?
4. How many valence electrons are there in each of these elements?

You will find that the number of valence electrons in all these elements from the group 1, that is, the family of alkali metals, is the same. Similarly, if you look at the elements from any other group, you will find the number of their valence electrons to be the same. For example, the elements beryllium (Be), magnesium (Mg) and calcium (Ca) belong to the group 2, that is, the family of alkaline earth metals. There are two electrons in their outermost shell. Similarly, there are seven electrons in the outermost shell of the elements such as fluorine (F) and chlorine (Cl) from the group 17, that is, the family of halogens. While going from top to bottom within any group, one electronic shell gets added at a time. From this we can say that the electronic configuration of the outermost shell is characteristic of a particular group. However, as we go down a group, the number of shells goes on increasing.



**Do you know ?**

Uranium has atomic number 92. All the elements beyond uranium (with atomic numbers 93 to 118) are manmade. All these elements are radioactive and unstable, and have a very short life.

### In the modern periodic table.....

1. Elements are arranged in an increasing order of their atomic numbers.
2. Vertical columns are called groups. There are 18 groups. The chemical properties of the elements in the same group show similarity and gradation.
3. Horizontal rows are called periods. There are in all 7 periods. The properties of elements change slowly from one end to the other in a period.



We can say that the elements with the same number of shells occupied by electrons belong to the same period. The elements in the second period, namely, Li, Be, B, C, N, O, F and Ne have electrons in the two shells, K and L. The elements in the third period, namely, Na, Mg, Al, Si, P, S, Cl and Ar have electrons in the three shells; K, L and M. Write down the electronic configuration of these elements and confirm. In the modern periodic table, electrons are filled in the same shell while going along a period from left to right, and at the beginning of the next period a new electron shell starts filling up (See the table 2.8).

The number of elements in the first three periods is determined by the electron capacity of the shells and the law of electron octet. (See the Table 2.9)



### Can you recall ?

1. What are the values of 'n' for the shells K, L and M?
2. What is the maximum number of electrons that can be accommodated in a shell? Write the formula.
3. Deduce the maximum electron capacity of the shells K, L and M.

As per the electron holding capacity of shells 2 elements are present in the first period and 8 elements in the second period. The third period also contains only eight elements due to the law of electron octet. There are few more factors which control the filling of electrons in the subsequent periods which will be considered in the next standards.

Shell	n	$2n^2$	Electron Capacity
K	1	$2 \times 1^2$	2
L	2	$2 \times 2^2$	8
M	3	$2 \times 3^2$	18
N	4	$2 \times 4^2$	32

### 2.9 Electron Capacity of Electron shells

The chemical reactivity of an element is determined by the number of valence electrons in it and the shell number of the valence shell. The information on these points is obtained from the position of the element in the periodic table. That is, the modern periodic table has proved useful for study of elements.

### Periodic trends in the modern periodic table

When the properties of elements in a period or a group of the modern periodic table are compared, certain regularity is observed in their variations. It is called the periodic trends in the modern periodic table. In this standard we are going to consider the periodic trends in only three properties of elements; namely, valency, atomic size and metallic- nonmetallic character.

**Valency :** You have learnt in the previous standard that the valency of an element is determined by the number of electrons present in the outermost shell of its atoms, that is, the valence electrons.



### Think about it

1. What is the relationship between the electronic configuration of an element and its valency?
2. The atomic number of beryllium is 4 while that of oxygen is 8. Write down the electronic configuration of the two and deduce their valency from the same.
3. The table on the next page is made on the basis of the modern periodic table. Write in it the electronic configuration of the first 20 elements below the symbol, and write the valency (as shown in a separate box).
4. What is the periodic trend in the variation of valency while going from left to right within a period? Explain your answer with reference to period 2 and period 3.
5. What is the periodic trend in the variation of valency while going down a group? Explain your answer with reference to the group 1, group 2 and group 18.



**Symbol**  
**Electronic configuration**  
**Valency**

**<sup>19</sup>K**  
**2, 8, 8, 1**  
**1**

	1						18
1		2	13	14	15	16	17
2							
3							
4							

**Atomic size**

You have seen in the previous standards that size/volume is a fundamental property of matter. The size of an atom is indicated by its radius. Atomic radius is the distance between the nucleus of the atom and its outermost shell.

Atomic radius is expressed in the unit picometer (pm) which is smaller than nanometer (1 pm = 10<sup>-12</sup> m).

Some elements and their atomic radii are given here.

<b>Element</b>	<b>:</b>	<b>O</b>	<b>B</b>	<b>C</b>	<b>N</b>	<b>Be</b>	<b>Li</b>
<b>Atomic radius (pm)</b>	<b>:</b>	<b>66</b>	<b>88</b>	<b>77</b>	<b>74</b>	<b>111</b>	<b>152</b>



**Use your brain power !**

1. By referring to the modern periodic table find out the periods to which the above elements belong.
2. Arrange the above elements in a decreasing order of their atomic radii.
3. Does this arrangement match with the pattern of the second period of the modern periodic table?
4. Which of the above elements have the biggest and the smallest atom?
5. What is the periodic trend observed in the variation of atomic radius while going from left to right within a period?

You will find that atomic radius goes on decreasing while going from left to right within a period. The reason behind this is as follows. While going from left to right within a period, the atomic number increases one by one, meaning the positive charge on the nucleus increases by one unit at a time. However, the additional electron gets added to the same outermost shell. Due to the increased nuclear charge the electrons are pulled towards the nucleus to a greater extent and thereby the size of the atom decreases.

<b>Element</b>	<b>:</b>	<b>K</b>	<b>Na</b>	<b>Rb</b>	<b>Cs</b>	<b>Li</b>
<b>Atomic radius (pm)</b>	<b>:</b>	<b>231</b>	<b>186</b>	<b>244</b>	<b>262</b>	<b>152</b>

Some elements and their atomic radii are given here.



**Use your brain power !**

1. By referring to the modern periodic table find out the groups to which above the elements belong.
2. Arrange the above elements vertically downwards in an increasing order of atomic radii.
3. Does this arrangement match with the pattern of the group 1 of the modern periodic table?
4. Which of the above elements have the biggest and the smallest atom?
5. What is the periodic trend observed in the variation of atomic radii down a group?

You will find that while going down a group the atomic size goes on increasing. This is because while going down a group a new shell is added. Therefore the distance between the outermost electron and the nucleus goes on increasing. As a result of this the atomic size increases in spite of the increased nuclear charge.

## Metallic- Nonmetallic Character



Use your brain power !

1. Look at the elements of the third period. Classify them into metals and nonmetals.
2. On which side of the period are the metals? Left or right?
3. On which side of the period did you find the nonmetals?

It is seen that the metallic elements like sodium, magnesium are towards the left. The nonmetallic elements such as sulphur, chlorine are towards the right. The metalloid element silicon lies in between these two types. A similar pattern is also observed in the other periods.

It is seen that the zig- zag line separates the metals from nonmetals in the periodic table. Elements appear to have arranged in such a way that metals are on left side of this line, nonmetals on the right side and metalloids are along the border of this line. How did this happen?

Let us compare the characteristic chemical properties of metals and nonmetals. It is seen from the chemical formulae of simple ionic compounds that the cation in them is formed from a metal while the anion from a nonmetal. From this it is understood that metal atoms have a tendency to form a cation by losing its valence electron, this property is called electropositivity of an element. On the other hand an atom of a nonmetal has a tendency to form an anion by accepting electrons from outside into its valence shell. We have already seen that ions have a stable electronic configuration of a noble gas. How is the ability to lose or accept electrons in the valence shell determined? All the electrons in any atom are held by the attractive force exerted on them by the positively charged nucleus. Electrons in the inner shells lie in between the valence shell and the nucleus. Because of their presence the effective nuclear charge exerting an attractive force on the valence electrons is somewhat less than the actual nuclear charge. Thus, the number of valence electrons in metals is small (1 to 3). Also the effective nuclear charge exerting attractive force on the valence electrons is small. As a combined effect of these two factors metals have a tendency to lose the valence electrons to form cations having a stable noble gas configuration. This tendency of an element called electropositivity is the metallic character of that element.

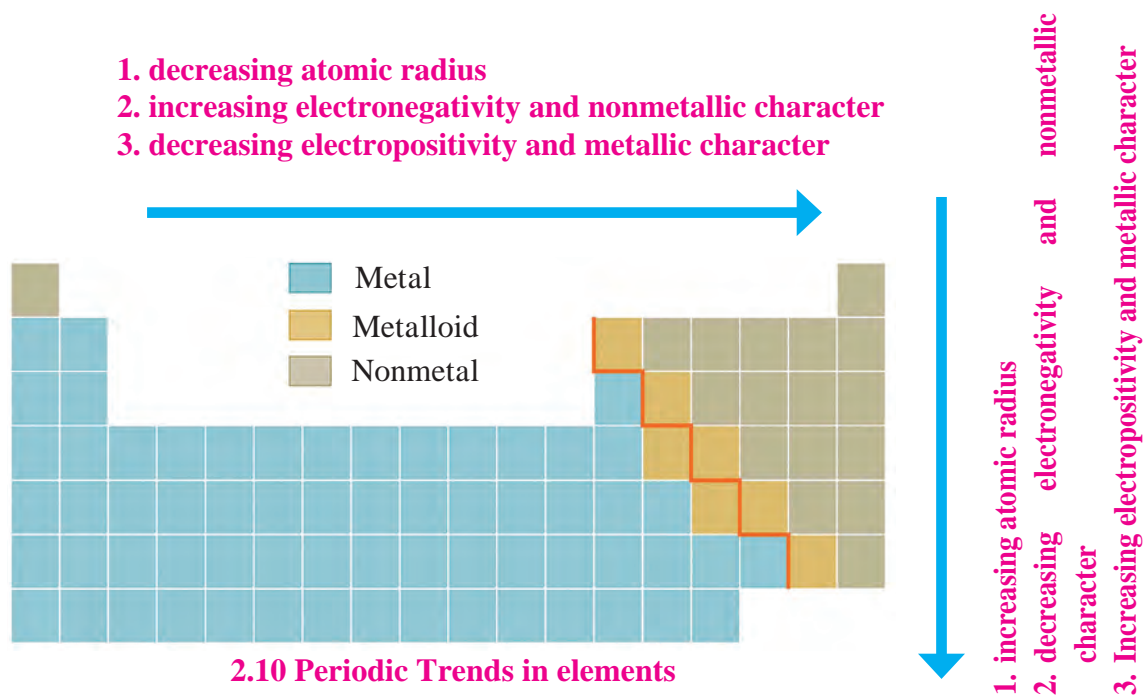

The periodic trend in the metallic character of elements is clearly understood from their position in the modern periodic table. Let us first consider the metallic character of elements belonging to the same group. While going down a group a new shell gets added, resulting in an increase in the distance between the nucleus and the valence electrons. This results in lowering the effective nuclear charge and thereby lowering the attractive force on the valence electrons. As a result of this the tendency of the atom to lose electrons increases. Also the penultimate shell becomes the outermost shell on losing valence electrons. The penultimate shell is a complete octet. Therefore, the resulting cation has a special stability. Due to this, the tendency of the atom to lose electrons increases further. The metallic character of an atom is its tendency to lose electrons. Therefore, the following trend is observed : The metallic character of elements increases while going down the group.

While going from left to right within a period the outermost shell remains the same. However, the positive charge on the nucleus goes on increasing while the atomic radius goes on decreasing and thus the effective nuclear charge goes on increasing. As a result of this the tendency of atom to lose valence electrons decreases within a period from left to right (See Table 2.10).

The two factors namely, the increasing nuclear charge and decreasing atomic radius as we go from left to right within a period, are responsible for increasing the effective nuclear charge. Therefore, the valence electrons are held with greater and greater attractive force. This is called electronegativity of an atom. Due to increasing electronegativity from left to right within a period, the ability of an atom to become anion by accepting outside electrons goes on increasing. The tendency of an element to form anion or the electronegativity is the nonmetallic character of an element.



Use your brain power !

1. What is the cause of nonmetallic character of elements?
2. What is the expected trend in the variation of nonmetallic character of elements from left to right in a period?
3. What would be the expected trend in the variation of nonmetallic character of elements down a group?



Always remember

1. While going downwards in any group the electropositivity of elements goes on increasing while their electronegativity goes on decreasing.
2. While going from left to right in any period the electronegativity of elements goes on increasing while their electropositivity goes on decreasing.
3. Larger the electropositivity or electronegativity of the element higher the reactivity.

### Gradation in Halogen Family

The group 17 contains the members of the halogen family. All of them have the general formula  $X_2$ . A gradation is observed in their physical state down the group. Thus, fluorine ( $F_2$ ) and chlorine ( $Cl_2$ ) are gases, bromine ( $Br_2$ ) is a liquid while iodine ( $I_2$ ) is a solid.



Internet my friend

Collect the information & mail it

1. Inert gas elements.
2. Uses of various elements.

Read the following reference books from your library.

1. Understanding chemistry - C.N.R. Rao
2. The Periodic Table Book: A Visual Encyclopedia of the Elements



### Do you know ?

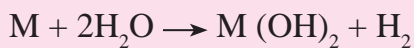

A general chemical equation indicating the reaction of alkaline earth metals is given above. While going down the second group as  $Be \rightarrow Mg \rightarrow Ca \rightarrow Sr \rightarrow Ba$ , the gradation in this chemical property of the alkaline earth metals is seen. While going down the second group the reactivity of the alkaline earth metals goes on increasing and thereby the ease with which this reaction takes place also goes on increasing. Thus beryllium (Be) does not react with water. Magnesium (Mg) reacts with steam, while calcium (Ca), strontium (Sr) and barium (Ba) react with water at room temperature with increasing rates.

## Exercise



### 1. Rearrange the columns 2 and 3 so as to match with the column 1.

Column 1	Column 2	Column 3
i. Triad	a. Lightest and negatively charged particle in all the atoms	1. Mendeleev
ii. Octave	b. Concentrated mass and positive charge	2. Thomson
iii. Atomic number	c. Average of the first and the third atomic mass	3. Newlands
iv. Period	d. Properties of the eighth element similar to the first	4. Rutherford
v. Nucleus	e. Positive charge on the nucleus	5. Dobereiner
vi. Electron	f. Sequential change in molecular formulae	6. Moseley

### 2. Choose the correct option and rewrite the statement.

a. The number of electrons in the outermost shell of alkali metals is.....

(i) 1 (ii) 2 (iii) 3 (iv) 7

b. Alkaline earth metals have valency 2. This means that their position in the modern periodic table is in .....

(i) Group 2 (ii) Group 16  
(iii) Period 2 (iv) d-block

c. Molecular formula of the chloride of an element X is  $XCl$ . This compound is a solid having high melting point. Which of the following elements be present in the same group as X.

(i) Na (ii) Mg (iii) Al (iv) Si

d. In which block of the modern periodic table are the nonmetals found?

(i) s-block (ii) p-block  
(iii) d-block (iv) f-block

### 3. An element has its electron configuration as 2,8,2. Now answer the following questions.

a. What is the atomic number of this element?

b. What is the group of this element?

c. To which period does this element belong?

d. With which of the following elements would this element resemble? (Atomic numbers are given in the brackets)

N (7), Be (4), Ar (18), Cl (17)



4. Write down the electronic configuration of the following elements from the given atomic numbers. Answer the following question with explanation.

- a.  ${}^3\text{Li}$ ,  ${}^{14}\text{Si}$ ,  ${}^2\text{He}$ ,  ${}^{11}\text{Na}$ ,  ${}^{15}\text{P}$  Which of these elements belong to be period 3?
- b.  ${}^1\text{H}$ ,  ${}^7\text{N}$ ,  ${}^{20}\text{Ca}$ ,  ${}^{16}\text{S}$ ,  ${}^4\text{Be}$ ,  ${}^{18}\text{Ar}$   
Which of these elements belong to the second group?
- c.  ${}^7\text{N}$ ,  ${}^6\text{C}$ ,  ${}^8\text{O}$ ,  ${}^5\text{B}$ ,  ${}^{13}\text{Al}$   
Which is the most electronegative element among these?
- d.  ${}^4\text{Be}$ ,  ${}^6\text{C}$ ,  ${}^8\text{O}$ ,  ${}^5\text{B}$ ,  ${}^{13}\text{Al}$   
Which is the most electropositive element among these?
- e.  ${}^{11}\text{Na}$ ,  ${}^{15}\text{P}$ ,  ${}^{17}\text{Cl}$ ,  ${}^{14}\text{Si}$ ,  ${}^{12}\text{Mg}$   
Which of these has largest atoms?
- f.  ${}^{19}\text{K}$ ,  ${}^3\text{Li}$ ,  ${}^{11}\text{Na}$ ,  ${}^4\text{Be}$   
Which of these atoms has smallest atomic radius?
- g.  ${}^{13}\text{Al}$ ,  ${}^{14}\text{Si}$ ,  ${}^{11}\text{Na}$ ,  ${}^{12}\text{Mg}$ ,  ${}^{16}\text{S}$   
Which of the above elements has the highest metallic character?
- h.  ${}^6\text{C}$ ,  ${}^3\text{Li}$ ,  ${}^9\text{F}$ ,  ${}^7\text{N}$ ,  ${}^8\text{O}$   
Which of the above elements has the highest nonmetallic character?

5. Write the name and symbol of the element from the description.

- a. The atom having the smallest size.
- b. The atom having the smallest atomic mass.
- c. The most electronegative atom.
- d. The noble gas with the smallest atomic radius.
- e. The most reactive nonmetal.

6. Write short notes.

- a. Mendeleev's periodic law.
- b. Structure of the modern periodic table.
- c. Position of isotopes in the Mendeleev's and the modern periodic table.

7. Write scientific reasons.

- a. Atomic radius goes on decreasing while going from left to right in a period.
- b. Metallic character goes on decreasing while going from left to right in a period.
- c. Atomic radius goes on increasing down a group.
- d. Elements belonging to the same group have the same valency.
- e. The third period contains only eight elements even though the electron capacity of the third shell is 18.

8. Write the names from the description.

- a. The period with electrons in the shells K, L and M.
- b. The group with valency zero.
- c. The family of nonmetals having valency one.
- d. The family of metals having valency one.
- e. The family of metals having valency two.
- f. The metalloids in the second and third periods.
- g. Nonmetals in the third period.
- h. Two elements having valency 4.

**Project**

Find out the applications of all the inert gases, prepare a chart and display it in the class.



### 3. Chemical Reactions and Equations



- Chemical reactions
- Rules of writing chemical reaction
- Balancing a chemical equation
- Types of chemical reactions



**Can you recall?**

1. What are the types of molecules of elements and compounds?
2. What is meant by valency of elements?
3. What is the requirement for writing molecular formulae of different compounds? How are the molecular formulae of the compounds written?

In earlier standards we have seen how compounds are formed by chemical combination of elements. We have also learnt that the driving force behind formation of a chemical bond is to attain an electronic configuration with a complete octet. The atoms attain a complete octet by giving, taking or sharing of electrons with each other.

#### Chemical Reaction

Some of the scientists of the 18<sup>th</sup> and 19<sup>th</sup> century carried out fundamental experiments on chemical reactions. They proved from their experiments that during chemical reactions composition of the matter changes and that change remains permanent. On the contrary during physical change only the state of matter changes and this change is often temporary in nature.

**Identify physical and chemical changes from the phenomena given in the following table.**

Phenomenon	Physical change	Chemical change
1. Transformation of ice into water.	✓	
2. Cooking of food.		✓
3. Ripening of fruit.		
4. Milk turned in to curd.		
5. Evaporation of water.		
6. Digestion of food in the stomach.		
7. Size reduction of naphtha balls exposed to air.		
8. Staining of Shahbad or Kadappa tile by lemon juice.		
9. Breaking of a glass object on falling from a height.		

#### 3.1 Some common phenomenon

**Note :** Do the following activities in a group of friends. Take help of your teacher wherever necessary.



**Try this.**

**Apparatus:** Thermometer, evaporating dish, tripod stand, funnel, Bunsen burner, etc.

**Chemicals :** Lime stone powder, copper sulphate, calcium chloride, potassium chromate, zinc dust, sodium carbonate, phthalic anhydride, etc.

**Procedure :** Carry out the activities 1 to 5 as given below. Read and record the temperatures in the activities 2 to 4.

1. Take a spoonful of lime stone powder in an evaporating dish. Heat it strongly on a high blue flame.
2. Add zinc (Zn) dust into the copper sulphate ( $\text{CuSO}_4$ ) solution.
3. Add potassium chromate ( $\text{K}_2\text{CrO}_4$ ) solution to barium sulphate ( $\text{BaSO}_4$ ) solution.
4. Add sodium carbonate ( $\text{Na}_2\text{CO}_3$ ) solution to the calcium chloride ( $\text{CaCl}_2$ ) solution.
5. Take phthalic anhydride in the evaporating dish.

Close the end of the stem of a funnel with a cotton plug. Keep this funnel inverted on the evaporating dish. Heat the evaporating dish on a tripod stand slowly on a low flame. What did you observe in the funnel during heating?

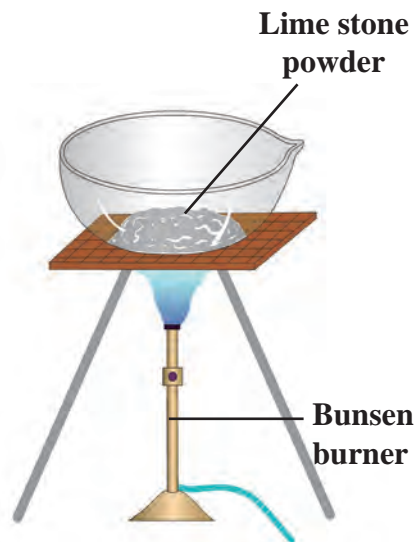

**3.2 To heat lime stone powder**

Record the observation of all the activities. What did you find?

**Complete the following observation table with reference to the activities 1 to 5.**

Activity	Colour change (if present)	Gas released (yes/no)	Temperature change (if present)	Nature of change (chemical /physical)
1				
2				
3				
4				
5				

### 3.3 Observation table



#### Find out

Observe and keep a record of the physical and chemical changes that you experience in your daily life.

A physical change takes place due to change in the parameters such as temperature, pressure. Often a physical change is reversible. The composition of matter remains the same in a physical change. For example, ice is transformed into water on heating and water is transformed into ice on cooling. On the contrary, if the composition of matter changes during a process then it is called a chemical change. When we call a particular process or phenomenon as a chemical change, some chemical reactions are taking place in the concerned matter.

A chemical reaction is a process in which some substances undergo bond breaking and are transformed into new substances by formation of new bonds. The substances taking part in chemical reaction are called reactants, whereas the substances formed as a result of a chemical reaction by formation of new bonds are called products. For example, formation of carbon dioxide gas by combustion of coal in air is a chemical reaction. In this reaction coal (carbon) and oxygen (from air) are the reactants while carbon dioxide is the product. A chemical reaction is represented by writing a chemical equation.

## Chemical equations

Let us first look at a chemical reaction. In the activity 2, a colourless solution of zinc sulphate ( $\text{ZnSO}_4$ ) is formed on addition of zinc dust to the blue solution of copper sulphate ( $\text{CuSO}_4$ ). This chemical reaction can be written in brief as follows.

Aqueous solution of copper sulphate + zinc dust  $\longrightarrow$  Aqueous solution of zinc sulphate + copper ..... (1)

This simple way of representing a chemical reaction in words is called a 'Word Equation'.

A word equation can be written in a further condensed form by using chemical formulae as follows.



The representation of a chemical reaction in a condensed form using chemical formulae is called as the chemical equation. In the above equation copper sulphate ( $\text{CuSO}_4$ ) and zinc ( $\text{Zn}$ ) are the reactants. They react with each other to form copper particles ( $\text{Cu}$ ) and a solution of the colourless zinc sulphate ( $\text{ZnSO}_4$ ) as the products having totally different properties. The ionic bond in the reactant  $\text{CuSO}_4$  breaks and the ionic bond in the product  $\text{ZnSO}_4$  is formed during the reaction.

## Writing a Chemical Equation

Let us now see the conventions followed while writing a chemical equation.

1. In a chemical equation the reactants are written on the left hand side while the products on the right hand side. An arrow heading towards the products is drawn in between them. This arrow indicates the direction of the reaction.

2. If the reactants or products are two or more, they are linked with a plus sign (+) in between them. For example, in the equation (2) a plus sign (+) is drawn in between the reactants  $\text{CuSO}_4$  and  $\text{Zn}$ . Similarly, a plus sign (+) is drawn in between the products  $\text{ZnSO}_4$  and  $\text{Cu}$ .

3. To make the chemical equation more informative the physical states of the reactants are indicated in the equation. Their gaseous, liquid and solid states are indicated by writing the letters (g), (l) and (s), respectively in the brackets. Moreover, if the product is gaseous, instead of (g) it can be indicated by an arrow  $\uparrow$  pointing upwards. If the product formed is insoluble solid, in the form of a precipitate, then instead of (s) it can be indicated by an arrow  $\downarrow$  pointing downwards. When reactants and products are in the form of solution in water, they are said to be present in aqueous solution state. This state is indicated by putting the letters aq in brackets after their formula. Thus, the equation (2) is rewritten as equation (3) shown below.



4. When heat is to be given from outside to bring about a reaction, it is indicated by the sign  $\Delta$  written above the arrow that indicates the direction of the reaction. For example, the reaction in which slaked lime is formed on heating lime stone is written as follows.

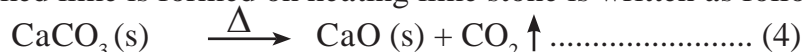

Similarly, the fact that heat is released during the reaction between the aqueous solution of copper sulphate and zinc dust is indicated as follows.

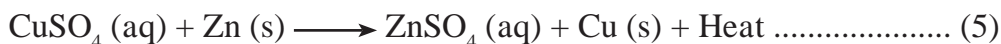

5. It is necessary to fulfill certain conditions like specific temperature, pressure, catalyst, etc. to bring about some reactions. These conditions are indicated below or above the arrow indicating the direction of the reaction. For example, the reaction of a vegetable oil takes place at the temperature of  $60^\circ\text{C}$  with hydrogen gas in presence of the Ni catalyst and is written as follows.





6 . Special information or names of reactants/ products are written below their formulae. For example, copper on reaction with concentrated nitric acid gives reddish coloured poisonous nitrogen di oxide gas.

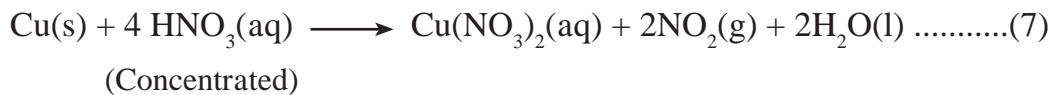

However, on reaction with dilute nitric acid, the product formed is nitric oxide gas.

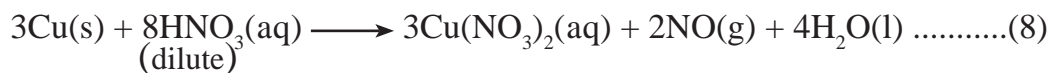

**Try this.**

**Apparatus:** Test tube, conical flask, balance, etc.

**Chemicals :** Sodium chloride and silver nitrate.

**Procedure :**

1. Take sodium chloride solution in a conical flask and silver nitrate solution in a test tube.
2. Tie a thread to the test tube and insert it carefully into the conical flask. Make the conical flask air tight by fitting a rubber cork.
3. Weigh the conical flask with the help of a balance.
4. Now tilt the conical flask and mix the solution present in the test tube with the solution in the conical flask.
5. Weigh the conical flask again.

Which changes did you find? Did any insoluble substance form? Was there any change in the weight?

A word equation is written for the above activity as shown below.



The above word equation is represented by the following chemical equation.

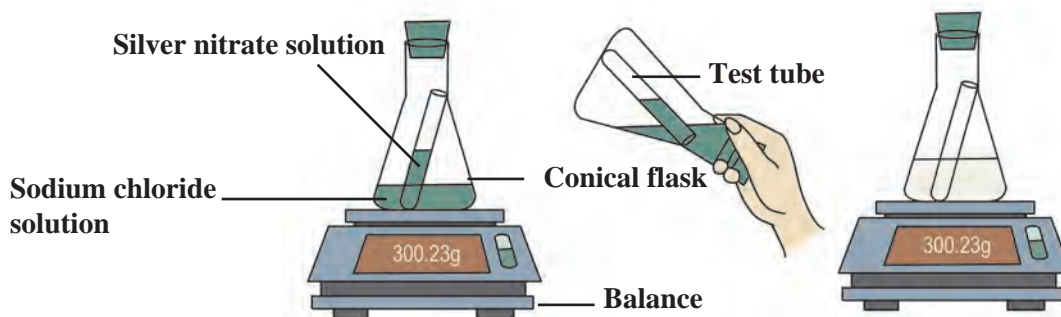
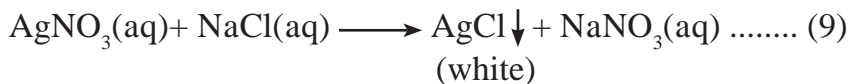

**3.4 The reaction of sodium chloride with silver nitrate**



**Do you know ?**

Silver nitrate is used in the voters-ink.



**Find out**

What are the other uses of silver nitrate in everyday life?

## Balancing a Chemical Equation

Complete the table aside on the basis of the equation (9).

It is seen that the number of atoms of the elements in the reactants in this equation is same as the number of atoms of those elements in the products. Such an equation is called a 'balanced equation'. If the number of atoms of each element is not the same on the two sides of an equation, it is called an 'unbalanced equation'.

	Reactants (Left side)	Products (Right side)
Element	Number of atoms	Number of atoms
Ag		
N		
O		
Na		
Cl		

### 3.5 Details of equation (9)



**Always remember**

In any reaction, the total mass of each of the elements in the reactants is same as the total mass of each of the respective elements in the products. This is in accordance with the law of conservation of mass that you studied in the previous standard.

### Steps in balancing a chemical reaction

A chemical equation is balanced step by step. A trial and error method is used for this purpose. Consider the following equation as an example :

Sodium hydroxide + Sulphuric acid  $\longrightarrow$  Sodium sulphate + water.

**STEP I. Write the chemical equation from the given word equation.**

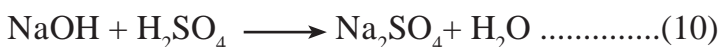

**STEP II. Check whether the equation (10) is balanced or not by comparing the number of atoms of the various elements present on the two sides of the equation.**

It is seen that the number of atoms of all the elements on the two sides are not the same. It means that the equation (10) is not balanced.

	Reactants (Left side)	Products (Right side)
Element	Number of atoms	Number of atoms
Na	1	2
O	5	5
H	3	2
S	1	1

**STEP III : It is convenient to start balancing an equation from the compound which contains the maximum number of atoms. Moreover it is convenient to first consider that element in this compound, which has unequal number of atoms on the two sides.**

(i) In the equation (10), there are two components  $\text{Na}_2\text{SO}_4$  and  $\text{H}_2\text{SO}_4$ , which contain the maximum number that is seven atoms each. Any one of them can be selected. Select the compound  $\text{Na}_2\text{SO}_4$ . Further select sodium for balancing as the number of atoms of sodium in this compound is unequal on the two sides. It should be remembered that, the formula of a compound cannot be changed while balancing the number of atoms. It means that, here to make the number of sodium atoms in the reactants as '2' the formula  $\text{NaOH}$  cannot be changed to  $\text{Na}_2\text{OH}$ . Instead a factor of '2' will have to be applied to  $\text{NaOH}$ . Write down the resulting equation (10)' on doing this.

Number of sodium atoms	In the Reactants (in $\text{NaOH}$ )	In the Products (in $\text{Na}_2\text{SO}_4$ )
Initially	1	2
To balance	1 x 2	2



(ii) Check whether the equation (10)' is balanced or not.

We find that the equation (10)' is not balanced, as the number of oxygen and hydrogen atoms are unequal on the two sides. First balance the hydrogen number as it requires a smaller factor.

(iii) Apply a factor '2' to the product 'H<sub>2</sub>O' for balancing the equation (10)'

Now write down the resulting equation (10)''.



(iv) Check whether the equation (10)'' is balanced or not. It is seen that the number of atoms of all the elements are equal on both the sides. It means that the equation (10)'' is a balanced equation.

	Reactants (Left side)	Products (Right side)
Element	Number of atoms	Number of atoms
Na	2	2
O	6	5
H	4	2
S	1	1

**Step IV : Write down the final balanced equation again.**



In this way, a balanced equation is obtained from an unbalanced equation by applying proper factors to appropriate reactant/product so as to balance the number of each element in steps.

Number of atoms of Hydrogen	In the reactants (In NaOH & H <sub>2</sub> SO <sub>4</sub> )	In the Products (In H <sub>2</sub> O)
i) Initially	4	2
ii) To balance	4	2 x 2



**Use your brain power!**

1. (a) Identify the reactants and products of equation (6).

(b) Write down the steps in balancing the equation  

$$\text{N}_2(\text{g}) + \text{H}_2(\text{g}) \rightleftharpoons \text{NH}_3(\text{g})$$

2. Write down a balanced chemical equation for the following reaction

Calcium chloride + Sulfuric acid  $\longrightarrow$  Calcium sulphate + hydrogen chloride

3. Write down the physical states of reactants and products in following reactions.



We saw that in a chemical reactions reactants get converted into the new substances called products. During this some chemical bonds in the reactants break and some new chemical bonds are formed so as to transform the reactants into the products. In this chapter we will be studying the types of reactions in detail.

### Types of chemical reactions

Chemical reactions are classified into the following four types in accordance with the nature and the number of the reactants and the products.

#### 1. Combination reaction



**Try this.**

**Apparatus:** Test tube, glass rod, beaker, etc.

**Chemicals:** hydrochloric acid, ammonia solution, slaked lime, etc.

**Activity 1:** Take a small amount of hydrochloric acid in a test tube. Heat the test tube. Dip a glass rod in the ammonia solution and hold on the top of the test tube. You will observe a white smoke emanating from the tip of the glass rod.

What must have happened?

Due to heating HCl vapours started coming out from the test tube, and NH<sub>3</sub> gas came out from the solution on the glass rod. The ammonia gas and hydrogen chloride gas reacted to form the salt ammonium chloride in gaseous state first, but immediately due to the condensation process at room temperature it got transformed into the solid state. As a result white smoke was formed. The chemical equation for this is as follows.

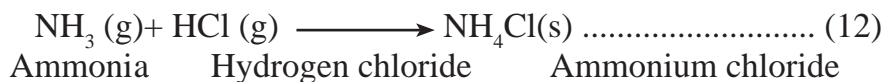

**Activity 2:** Hold a magnesium (Mg) strip in a pair of tongs and ignite. On burning in air a white powder of magnesium oxide is formed. The reaction can be written in the form of equation as shown below.



In this reaction magnesium oxide is formed as the single product by combination of magnesium and oxygen.

**Activity 3:** Take water in a beaker up to half of its capacity. Add a few pieces of slaked lime (calcium oxide, CaO) to it. Calcium hydroxide (Ca (OH)<sub>2</sub>) is formed by combination of calcium oxide and water with generation of large amount of heat.

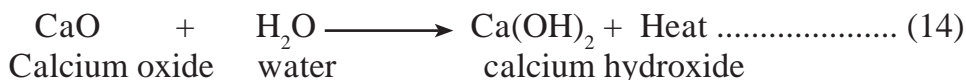

**Use your brain power!**

1. What is the number of reactants in each of the above reactions?
2. What is the number of molecules of reactants taking part in the above reactions?
3. How many products are formed in each of the above reactions?

**When two or more reactants combine in a reaction to form a single product, it is a combination reaction.**

## 2. Decomposition reaction



**Try this.**

**Apparatus:** Evaporating dish, Bunsen burner, etc.

**Chemicals :** Sugar, calcium carbonate, sulphuric acid, etc.

**Procedure:** Take some sugar in an evaporating dish and heat it with the help of a Bunsen burner. After some time you will see the formation of a burnt out black substance. Exactly what must have happened in this activity?

In the above activity a single reactant sugar is divided into two substances (C and H<sub>2</sub>O)

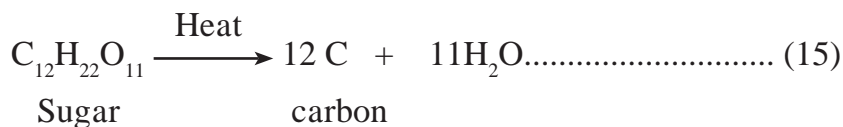

The reaction in which there is only one reactant giving rise to two or more products is called a decomposition reaction.





**Try this.**

**Apparatus :** Two test tubes, bent tube, rubber cork, burner, etc.

**Chemicals :** Calcium carbonate, freshly prepared lime water.

**Procedure :** Take some calcium carbonate in a test tube. Fit a bent tube to this test tube with the help of a rubber cork. Insert the other end of the bent tube in the freshly prepared lime water taken in the other test tube. Heat the powdered calcium carbonate in the first test tube strongly. The lime water will turn milky.

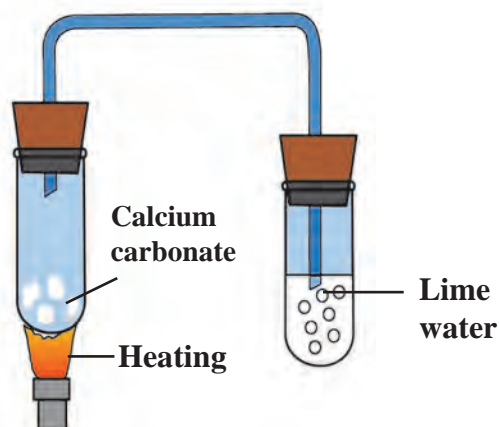

### 3.6 Decomposition of calcium carbonate

We saw in the above activity that calcium carbonate undergoes decomposition reaction and the carbon dioxide gas formed turns the lime water milky (Eq. 16). The second product of the reaction, the calcium oxide powder, remains behind in the first test tube. Similarly, in another reaction (Eq. 17) hydrogen peroxide naturally undergoes slow decomposition into water and oxygen.



(16) and (17) both are decomposition reactions.



**Can you recall?**

Is it possible to produce hydrogen by decomposition of water by means of heat, electricity or light ?

We have studied in the previous standard that water decomposes into hydrogen and oxygen gases on passing electric current through acidulated water. This decomposition takes place by means of electrical energy. Therefore it is called electrolysis.



**The chemical reaction in which two or more products are formed from a single reactant is a “Decomposition reaction”.**

Many degradation processes take place in the nature surrounding us. Organic waste is decomposed by microorganisms and as a result manure and biogas are formed. Biogas is used as a fuel.

### 3. Displacement reaction

We saw in the beginning of this chapter that on adding zinc dust to blue coloured copper sulphate solution, a colourless solution of zinc sulphate is formed and heat is generated. See the equation (3) for this reaction.

From that we learnt that the  $\text{Zn}^{2+}$  ions formed from Zn atoms take the place of  $\text{Cu}^{2+}$  ions in copper sulphate, and Cu atoms, formed from  $\text{Cu}^{2+}$  ion come out. It means that Zn displaces Cu from  $\text{CuSO}_4$ .

**The reaction in which the place of the ion of a less reactive element in a compound is taken by another more reactive element by formation of its own ions, is called displacement reaction.**

(We will learn about reactivity of elements in the chapter on metallurgy.) The elements iron and lead, similar to zinc, displace copper from its compound.



**Use your brain power !**

Complete the following reactions and give names of the products.



### 4. Double displacement reaction

We have seen in the equation (9) that a white precipitate of silver chloride is formed by an exchange of silver and sodium ions present in the reactants.

**The reaction in which the ions in the reactants are exchanged to form a precipitate is a double displacement reaction.**

Recall the activity (3) in which you added potassium chromate ( $\text{K}_2\text{CrO}_4$ ) into the solution of barium sulphate ( $\text{BaSO}_4$ ).

1. What was the colour of the precipitate formed ?
2. Write the name of the precipitate.
3. Write down the balanced equation for this reaction.
4. Will you call this reaction a displacement reaction or a double displacement reaction.

### Endothermic and Exothermic Processes and Reaction :

Heat is absorbed and given away in various processes and reactions. Accordingly processes and reactions are classified as 'Endothermic or Exothermic'.

#### Endothermic and Exothermic Processes

Heat from outside is absorbed during some physical changes. For example, (i) melting of ice (ii) dissolution of potassium nitrate in water. Therefore, these are '**Endothermic processes.**'

On the other hand, heat is given away during some physical changes. For example, (i) formation of ice from water, (ii) dissolution of sodium hydroxide in water. Therefore these are '**Exothermic processes.**' In the process of dilution of concentrated sulphuric acid with water, very large amount of heat is liberated. As a result, water gets evaporated instantaneously, if it is poured in to the concentrated sulphuric acid, which may cause an accident. To avoid this, required amount of water is taken in a glass container and small quantity of concentrated sulphuric acid at a time is added with stirring. Therefore, only a small amount of heat is liberated at a time.

## To carry out endothermic and exothermic processes



### Try this.

**Apparatus :** Two plastic bottles, measuring cylinder, thermometer etc.

**Chemicals :** Potassium nitrate, sodium hydroxide, water etc.

**(Sodium hydroxide being corrosive, handle it carefully in presence of Teacher.)**

**Procedure :** Take 100 ml water in each of the two plastic bottles. Plastic being insulator of heat, the dissipation of heat can be prevented. Note the temperature of water in the bottles. Put 5 g potassium nitrate ( $\text{KNO}_3$ ) in the bottle and shake well. Note the temperature of the solution formed. Put 5 g sodium hydroxide ( $\text{NaOH}$ ) in the other bottle. Shake the bottle well. Note the temperature.

In the first bottle the process of dissolution of potassium nitrate took place while in the second bottle the process of dissolution of sodium hydroxide took place. As per your observation which one is exothermic process and which is an endothermic process?

During the process of the dissolution of  $\text{KNO}_3$  in water, heat from the surroundings is absorbed and therefore the temperature of the resulting solution is less. The process in which heat is absorbed from the outside, is called endothermic process. When the solid  $\text{NaOH}$  is dissolved in water heat is given out, and therefore the temperature increases. The processes in which heat is given out are called exothermic processes.

### Endothermic and Exothermic Reactions

There is an exchange of heat in chemical reactions as well. Accordingly some chemical reactions are exothermic while some other are endothermic. During exothermic chemical reactions heat is given away when reactants are transformed into the products, while during endothermic chemical reactions heat is either absorbed from the surroundings or has to be supplied continuously from outside. For example,

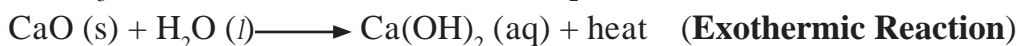

### Use your brain power !

1. What is the difference in the process of dissolution and a chemical reaction ?
2. Does a new substance form when a solute dissolves in a solvent ?

### Rate of Chemical Reaction



### Can you tell?

Take into account the time required for following processes. Classify them into two groups and give titles to the groups.

1. Cooking gas starts burning on ignition .
2. Iron article undergoes rusting.
3. Erosion of rocks takes place to form soil.
4. Alcohol is formed on mixing yeast in glucose solution under proper condition.
5. Effervescence is formed on adding baking soda into a test tube containing dilute acid.
6. A white precipitate is formed on adding dilute sulphuric acid to barium chloride solution.

It can be seen from the above examples that some reactions are completed in short time, that is, occur rapidly, while some other require long time for completion, that is, occur slowly. It means that the rate of different reactions is different.

The same reaction occurs at a different rate on changing the conditions. For example, during winter long time is required for setting milk into curd, while at the higher temperature during summer, the rate of setting of milk increases and the curd is formed early.

Now let us see the factors which decide the rate of a chemical reaction.

## Factors affecting the rate of a chemical reaction

### a. Nature of the Reactants

Let us see the reaction of the metals aluminium (Al) and zinc (Zn) with dilute hydrochloric acid.

On reaction of both Al and Zn with dilute hydrochloric acid  $H_2$  gas is liberated and water soluble salts of these metals are formed. However, the reaction of aluminium metal takes place faster as compared to zinc metal. The nature of the metal is responsible for this difference. Al is more reactive than Zn. Therefore the rate of reaction of Al with hydrochloric acid is higher than that of Zn. Nature or reactivity of reactants influences the rate of a chemical reaction. (We are going to learn more about the reactivity of metals in the chapter on Metallurgy.)

### b. Size of the Particles of Reactants



**Try this.**

**Apparatus:** Two test tubes, balance, measuring cylinder, etc.

**Chemicals:** Pieces of Shahabad tile, powder of Shahabad tile, dilute HCl etc.

**Procedure :** Take pieces and powder of Shahabad tile in equal weights in two test tubes. Add 10 ml dilute HCl in each of the test tubes. Observe whether effervescence of  $CO_2$  is formed at a faster or slower speed.

You must have found in the above activity that the  $CO_2$  effervescence is formed slowly with the pieces of Shahabad tile while at a faster speed with the powder.

The above observation indicates that the rate of a reaction depends upon the size of the particles of the reactants taking part in the reaction. Smaller the size of the reactant particles, higher is the rate of the reaction.

### c. Concentration of the reactants

Let us consider the reaction of dilute and concentrated hydrochloric acid with  $CaCO_3$  powder.

Dilute HCl reacts slowly with  $CaCO_3$  and thereby  $CaCO_3$  disappears slowly and  $CO_2$  also liberates slowly. On the other hand the reaction with concentrated HCl takes place rapidly and  $CaCO_3$  disappears fast.

Concentrated acid reacts faster than dilute acid, which means that rate of a reaction is proportional to the concentration of reactants.

### d. Temperature of the Reaction

While studying decomposition reaction, you have carried out decomposition of lime stone. In this activity, the lime water does not turn milky before heating the lime stone; because of the zero rate of reaction. From this it is learnt that the rate of a reaction increases on increasing the temperature.



### e. Catalyst

On heating potassium chlorate ( $\text{KClO}_3$ ) decomposes slowly.



The rate of the above reaction neither increases by reducing the particle size nor by increasing the reaction temperature. However,  $\text{KClO}_3$  decomposes rapidly in presence of manganese dioxide ( $\text{MnO}_2$ ) to liberate  $\text{O}_2$  gas. No chemical change takes place in  $\text{MnO}_2$  in this reaction.

**“The substance in whose presence the rate of a chemical reaction increases, without causing any chemical change to it, is called a catalyst.”**

The decomposition of hydrogen peroxide into water and oxygen takes place slowly at room temperature (Eq. 17). However, the same reaction occurs at a faster rate on adding manganese dioxide ( $\text{MnO}_2$ ) powder in it.



#### Do you know ?

1. One or more chemical reactions take place during every chemical change.
2. Some chemical reactions occur at fast speed whereas some occur at slow speed.
3. Strong acid and strong base react instantaneously.
4. In our body, enzymes increase the rate of physiological reactions.
5. Perishable foodstuff gets preserved longer in a refrigerator. The rate of decomposition of foodstuff gets lowered due to low temperature, and its freshness is maintained.
6. Vegetables cook quickly on oil rather than on water.
7. The chemical reactions are profitable in the chemical factories if their rate is fast.
8. The rate of chemical reaction is important from environmental point of view as well.
9. The ozone layer in the earth's atmosphere protects the life on earth from the ultraviolet radiation of the sun. The process of depletion or maintenance of this layer depends upon the rate of production or destruction of ozone molecules.

### Oxidation and Reduction

Many types of substances give reactions called oxidation and reduction. Let us learn more about these reaction.



In the reactions (20) and (21) a reactant combines with oxygen, whereas in (22) and (23) hydrogen gas is removed from the reactant. All these are examples of the oxidation reaction.

The chemical reaction in which a reactant combines with oxygen or loses hydrogen to form the product is called oxidation reaction.





### Can you tell?

Look at the chemical equation (6). What is the type of this reaction, in which Vanaspathi ghee is formed from vegetable oil?

The chemical reactions in which reactants gain hydrogen are called 'reduction' reactions. Similarly, the reaction in which a reactant loses oxygen to form the product is also called reduction reaction. The substance that brings about reduction is called a reductant, or a reducing agent.

When hydrogen gas is passed over black copper oxide a reddish coloured layer of copper is formed.

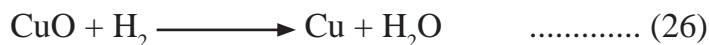

**Which is the reductant in this reaction? And which reactant has undergone reduction?**

In this reaction an oxygen atom goes away from CuO (copper oxide), which means that reduction of copper oxide takes place, whereas hydrogen molecule takes up oxygen atom and water (H<sub>2</sub>O) is formed meaning, oxidation of hydrogen takes place. Thus oxidation and reduction reactions occur simultaneously. The reductant is oxidized by the oxidant and the oxidant is reduced by the reductant. Due to this characteristics of the reduction and oxidation reactions, a single term 'redox reaction' is used in place of the two terms.

Redox Reaction = Reduction + Oxidation



### Use your brain power !

1. Some more examples of redox reaction are as follows. Identify the reductants and oxidants from them.

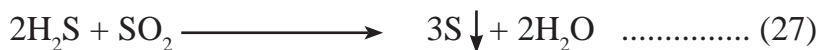

- If oxidation means losing electrons, what is meant by reduction?
- Write the reaction of formation of Fe<sup>2+</sup> by reduction Fe<sup>3+</sup> by making use of the symbol (e<sup>-</sup>).



### Think about it

The luster of the surface of the aluminium utensils in the house is lost after a few days. Why does this happen?

When the positive charge on an atom or an ion increases or the negative charge on them decreases it is called oxidation, and when the positive charge decreases or the negative charge increases it is called reduction.

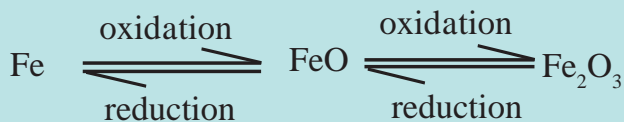

### Do you know ?

A redox reaction takes place during cellular respiration. Here the molecule of the enzyme called cytochrome C oxidase helps the transport of electron to bring about this reaction.

**For more information refer to life processes in the living organisms.**

## Corrosion



### Try This.

**Apparatus :** Four test tubes, four small iron nails, rubber cork, etc.  
**Chemicals :** Anhydrous calcium chloride, oil, boiled water, etc.

**Procedure :** Place four test tubes on a test tube stand. Take some boiled water in one test tube and put an oil layer on it. Take some salt water in the second test tube. Let there be only air in the third test tube. Take some anhydrous calcium chloride in the fourth test tube. Place a small iron nail in every test tube. Close the fourth test tube with a rubber cork. Let all the four test tubes remain unattended for a few days.

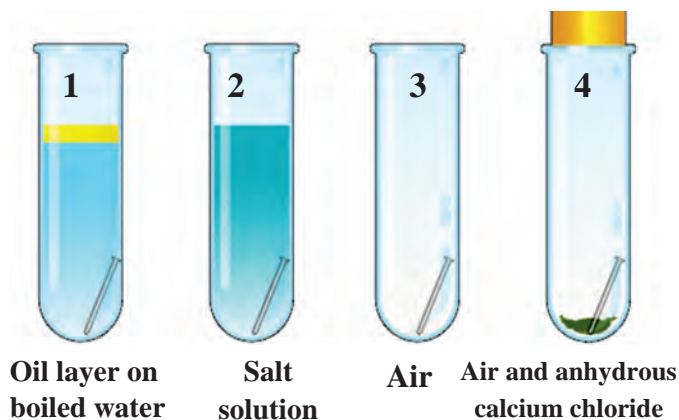

### 3.7 To study rusting

Observe all the four test tubes after a few days. What did you find? Which test tubes had the nails as before? Both water and air are necessary for rusting. The rusting process takes place rapidly in presence of a salt. Have you seen the effect of redox reaction in your everyday life? The new vehicles look shiny, on the contrary old vehicles look dull. A certain type of reddish coloured solid layer collects on their metallic surface. This layer is called 'rust'. Its chemical formula is  $\text{Fe}_2\text{O}_3 \cdot x\text{H}_2\text{O}$ .

The rust on iron does not form by a simple reaction of oxygen with iron surface. The rust is formed by an electrochemical reaction. Different regions on the surface of iron become anode and cathode.

1. Fe is oxidised to  $\text{Fe}^{2+}$  in the anode region.

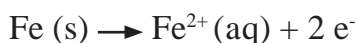

2.  $\text{O}_2$  is reduced to form water in the cathode region.

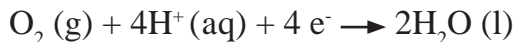

When  $\text{Fe}^{2+}$  ions migrate from the anode region they react with water and further get oxidised to form  $\text{Fe}^{3+}$  ions.

A reddish coloured hydrated oxide is formed from  $\text{Fe}^{3+}$  ions. It is called rust. It collects on the surface.



Due to various components of atmosphere, oxidation of metals takes place, consequently resulting in their damage. This is called 'corrosion'. Iron rusts and a reddish coloured layer is collected on it. This is corrosion of iron. Corrosion is a very serious problem. We are going to study about it in the 'metallurgy' chapter.



### Find out

How are the blackened silver utensils and patinated (greenish) brass utensils cleaned?



## Rancidity

When we use old, left over cooking oil for making food stuff, it is found to have foul odour called rancidity. If food is cooked in such oil, its taste also changes. When oil or ghee is left aside for a long time or fried food is left aside for a long time it undergoes air oxidation and becomes rancid. Rancidity in the food stuff cooked in oil or ghee is prevented by using antioxidants. The process of oxidation reaction of food stuff can also be slowed down by storing it in air tight container.

## Exercise



**1. Choose the correct option from the bracket and explain the statement giving reason.**

(Oxidation, displacement, electrolysis, reduction, zinc, copper, double displacement, decomposition)

- To prevent rusting, a layer of ..... metal is applied on iron sheets.
- The conversion of ferrous sulphate to ferric sulphate is ..... reaction.
- When electric current is passed through acidulated water ..... of water takes place.
- Addition of an aqueous solution of  $\text{ZnSO}_4$  to an aqueous solution of  $\text{BaCl}_2$  form a white precipitate is an example of ..... reaction.

**2. Write answers to the following.**

- What is the reaction called when oxidation and reduction take place simultaneously? Explain with one example.
- How can the rate of the chemical reaction, namely, decomposition of hydrogen peroxide be increased?
- Explain the term reactant and product giving examples.
- Explain the types of reaction with reference to oxygen and hydrogen. Illustrate with examples.
- Explain the similarity and difference in two events, namely adding NaOH to water and adding CaO to water.

**3. Explain the following terms with examples.**

- Endothermic reaction
- Combination reaction
- Balanced equation
- Displacement reaction

**4. Give scientific reasons.**

- When the gas formed on heating limestone is passed through freshly prepared lime water, the lime water turns milky.
- It takes time for pieces of Shahabad tile to disappear in HCl, but its powder disappears rapidly.
- While preparing dilute sulphuric acid from concentrated sulphuric acid in the laboratory, the concentrated sulphuric acid is added slowly to water with constant stirring.
- It is recommended to use air tight container for storing oil for long time.

**5. Observe the following picture a write down the chemical reaction with explanation.**

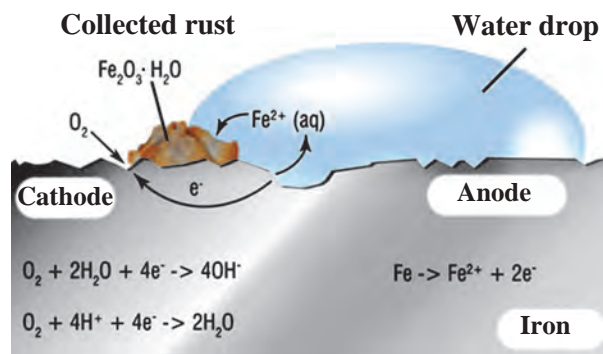

6. Identify from the following reactions the reactants that undergo oxidation and reduction.

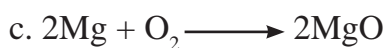

7. Balance the following equation stepwise.

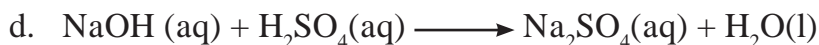
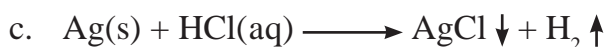
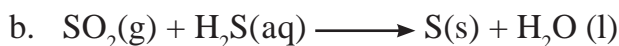

8. Identify the endothermic and exothermic reaction.



9. Match the column in the following table.

Reactants	Products	Type of chemical reaction
$\text{BaCl}_2(\text{aq}) + \text{ZnSO}_4(\text{aq})$	$\text{H}_2\text{CO}_3(\text{aq})$	Displacement
$2\text{AgCl}(\text{s})$	$\text{FeSO}_4(\text{aq}) + \text{Cu}(\text{s})$	Combination
$\text{CuSO}_4(\text{aq}) + \text{Fe}(\text{s})$	$\text{BaSO}_4 \downarrow + \text{ZnCl}_2(\text{aq})$	Decomposition
$\text{H}_2\text{O}(\text{l}) + \text{CO}_2(\text{g})$	$2\text{Ag}(\text{s}) + \text{Cl}_2(\text{g})$	Double displacement

### Project

Prepare aqueous solutions of various solid salts available in the laboratory. Observe what happens when aqueous solution of sodium hydroxide is added to these. Prepare a chart of double displacement reactions based on these observation.



## 4. Effects of electric current



- Energy transfer in electric circuit.
- Heating effects of electric current.
- Magnetic effects of electric current.



**Can you recall?**

1. How do we decide that a given material is a good conductor of electricity or is an insulator?
2. Iron is a conductor of electricity, but when we pick up a piece of iron resting on the ground, why don't we get electric shock?

We have learnt in earlier standards about static electricity. We performed various experiments regarding negatively and positively charged objects. The reason behind the object becoming positively and negatively charged is the transfer of negatively charged particles from one object to another object. In previous standard, we also studied about electric current.

In this chapter, we will study about an electric current flowing through a conducting wire, an electric current flowing through a resistor, electromagnetic induction, electric motor and generator.



**Observe and Discuss**

What do you observe in the following pictures?  
Which effects of electric current do you find?

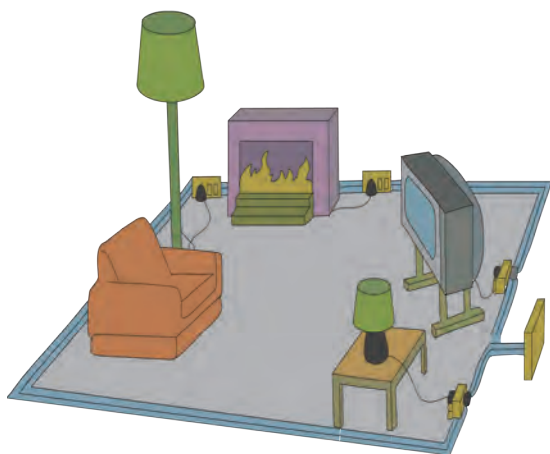

a



b

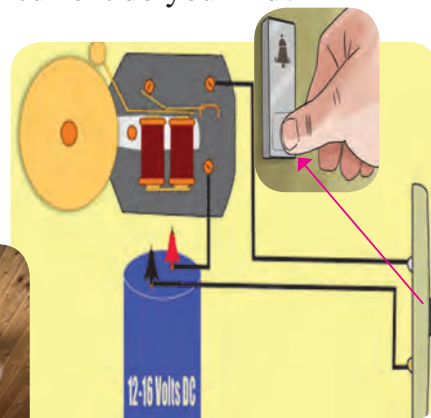

c

### 4.1 Effects of electric current

#### Energy transfer in an electric circuit



**Try this**

**Materials:** connecting wires, electric cells, electrical resistance, voltmeter, ammeter, plug key.

**Procedure:** Connect the circuit as shown in the accompanying figure 4.2 after taking the components with proper values. Measure the current ( $I$ ). Also measure the potential difference ( $V_{AB}$ ) between the two ends (A and B) of the resistance.

The potential at A is higher than the potential at B as the point A is connected to the positive electrode of the cell and the point B to the negative electrode of the cell.

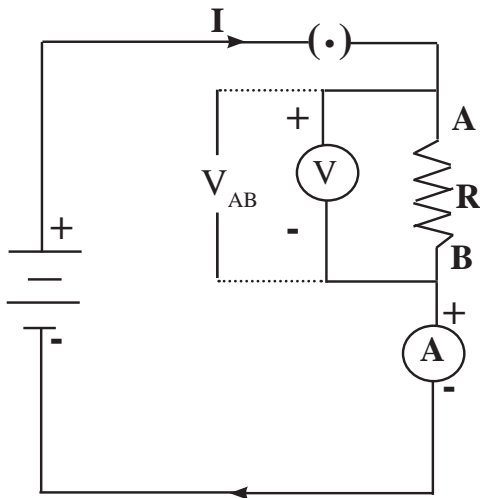

**4.2 Electric circuit**

If a charge  $Q$  flows from A to B, work  $V_{AB} Q$ , has been done on  $Q$  while going from A to B (Refer to chapter 3 of std 9). From where does the energy come to do this work? The source of energy is the cell. The cell gives this energy through the charge  $Q$  to the resistance where work  $V_{AB} Q$  is performed. If the charge  $Q$  flows from A to B in time  $t$ , i.e. the work is performed in time  $t$ , then during that time the energy  $V_{AB} Q$  is given to the resistor.

What happens to this energy? This energy is received by the resistor and is converted into heat energy, the temperature of the resistor is increased.



**Use your brain power !**

If in the circuit, the resistor is replaced by a motor, in which form will the energy given by the cell get transformed into?

$$P = \text{Electrical power} = \frac{\text{Energy}}{\text{Time required}} = \frac{V_{AB} Q}{t} = V_{AB} I \dots\dots\dots(1) \quad \because \quad \frac{Q}{t} = I ,$$

The source of energy, the cell, gives in time  $t$ , the energy  $P \times t$  to the resistor. If  $I$  is the current flowing continuously through the circuit, the heat produced in the resistor in time  $t$  will be

$$H = P \times t = V_{AB} \times I \times t \dots\dots\dots (2)$$

According to Ohm's law,

$$V_{AB} = I \times R \dots\dots\dots (3)$$

$$H = V_{AB}^2 \times \frac{t}{R} \dots\dots\dots (4)$$

$$\text{Similarly, } H = I \times I \times R \times t = I^2 \times R t \dots\dots\dots (5)$$

$H = I^2 \times R \times t$  is called Joules law of heating

**Unit of electrical power**

$$P = V_{AB} \times I = \text{Volt} \times \text{Amp} \dots\dots\dots (6)$$

$$1 \text{ Volt} \times 1 \text{ Amp} = \frac{1\text{J}}{1\text{C}} \times \frac{1\text{C}}{1\text{s}} \dots\dots\dots (7)$$

$$\frac{1\text{J}}{1\text{s}} = \text{W (watt)} \dots\dots\dots (8)$$

Thus the unit of electrical power is 1W (watt).



**Think about it**

How can we write mechanical power in a manner similar to the electrical power?

**Heating effect of electric current**

When a resistor is connected in an electrical circuit, heat is produced in it due to the current. This is known as the heating effect of current.





Coiled coil



Coil (Solenoid type)

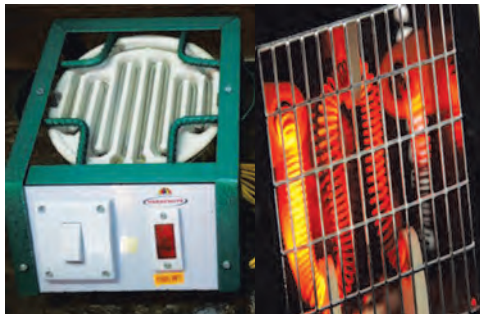

Coil of cooker

Coil of Heater

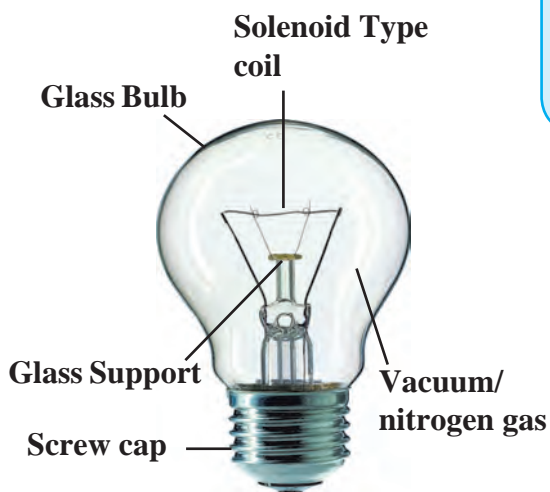

### 4.3 Uses of coil



#### Find out

Check monthly electricity bill received from the electricity distribution Co. Ltd. Observe various details and get information about them. The electricity bill specifies the usage in 'Units'. What is this unit? When 1 kWh electrical energy is used, it is termed as 1 unit of energy.

Equipment such as water boiler, electric cooker, electric bulb make use of the heating effect of electric current. Electrical conductors having higher resistivity are used here. For example, a coil made up of an alloy Nichrome is used in the electric heater-cooker as a resistor, while a tungsten wire is used in an electric bulb. Because of the current, this wire gets heated (to nearly 3400 °C) and emits light. The hot wire also radiates heat to a certain extent.



#### Always remember

The unit of electric power 1W is a very small unit, hence 1000 W or 1 kW is used as a unit to measure electric power, in practice. If 1 kW power is used for 1 hour, it will mean  $1\text{ kW} \times 1\text{ hr}$  of electrical energy is used (see equation 1)  
 $1\text{ kWh} = 1\text{ kilowatt hour} = 1000\text{ W} \times 3600\text{ s}$   
 $= 3.6 \times 10^6\text{ Ws} = 3.6 \times 10^6\text{ J}$

Several times we hear or read about a building catching fire due to short circuit. Sometimes, if we switch on an equipment in our house, the electrical fuse wire melts and the electric supply shuts down. Let us discuss about the cause briefly. The home electrical connection consists of 'live', 'neutral' and 'earth' wires. The 'live' and the 'neutral' wires have potential difference of 220V. The 'earth' is connected to ground. Due to a fault in the equipment or if the plastic coating on the 'live' and the 'neutral' wires gives way, the two wires come in contact with each other and a large current flows through it producing heat. If any inflammable material (such as wood, cloth, plastic etc.) exists around that place it can catch fire. Therefore, a fuse wire is used as a precautionary measure. We have learnt about fuse wire in the previous standard. As soon as high current flows in a circuit, the fuse wire melts and breaks the circuit and any mishap is avoided.

Many times particularly in the summer season, huge electrical power is used in the evenings due to home lighting, fans, air conditioners, use of electricity in shops etc. As a result, excessive current is drawn from the transformer supplying the electricity, and if the capacity of the transformer is insufficient, its fuse wire melts and the supply gets shut down. Such events occur due to overloading.



4.4 Different types of fuses in use



### Do you know ?

These days miniature circuit breakers (MCB) switches are used in homes. When the current in the circuit suddenly increases this switch opens and current stops. Different types of MCBs are in use. For the entire house, however the usual fuse wire is used.



### Solved examples

**Example 1.** A 6 m long wire made from an alloy, nichrome, is shaped into a coil and given for producing heat. It has a resistance of 22 ohms. Can we get more heat if the wire is cut into half of its original length and shaped into a coil? For getting energy, the two ends of the wire are connected to a source with a potential difference of 220V.

**Given :** Resistance 22 ohm, potential difference = 220 V

A. Coil of whole wire.

$$P = \frac{V^2}{R} = \frac{(220)^2}{22} = 2200 \text{ watts}$$

B. Coil of half-length wire

$$P = \frac{V^2}{R} = \frac{(220)^2}{11} = 4400 \text{ watts}$$

This means that more heat will be obtained after cutting the wire into half.

**Example 2.** A cell is connected to a 9 ohm resistance, because of which heat of 400 J is produced per second due to current flowing through it. Obtain the potential difference applied across the resistance.

**Given:**

Heat at 400 J per second means

$$P = \frac{400 \text{ J}}{1 \text{ s}}$$

$$P = \frac{V^2}{R}$$

$$400 = \frac{V^2}{9}$$

$$400 \times 9 = V^2$$

$$\therefore V = \sqrt{(400 \times 9)} = 20 \times 3 = 60 \text{ V}$$

**Example 3.** An electrical iron uses a power of 1100 W when set to higher temperature. If set to lower temperature, it uses 330 W power. Find out the electric current and the respective resistances for the two settings. The iron is connected to a potential difference of 220 V.

Given: potential difference = 220 V.

Power P = (A) 1100 W, (B) = 330 W.

A. Power = 1100 W.

$$I_1 = \frac{P}{V} = \frac{1100}{220} = 5 \text{ A}$$

B. Power = 330 W

$$I_2 = \frac{P}{V} = \frac{330}{220} = 1.5 \text{ A}$$

$$\text{Resistance } R_1 = \frac{V}{I_1} = \frac{220}{5} = 44 \Omega$$

$$\text{Resistance } R_2 = \frac{V}{I_2} = \frac{220}{1.5} = 146 \Omega$$

**Example 4.** An electric tungsten bulb is connected into a home circuit. The home electric supply runs at 220 V potential difference. When switched on, a current of 0.45 A flows through the bulb. What must be power (wattage) of the bulb? If it is kept on for 10 hours, how many units of electricity will be consumed?

**Given :** Potential difference = 220 V.

Current = 0.45 A.

$$\begin{aligned} \text{Power (W)} &= \text{Potential difference(V)} \\ &\quad \times \text{Current (A)} \\ &= 220 \times 0.45 \text{ W} \\ &= 99 \text{ W.} \end{aligned}$$

The bulb must be of power 99 W.

In 10 hrs,

$$\begin{aligned} 99 \text{ W} \times 10 \text{ h} &= 990 \text{ Wh.} \\ &= 0.99 \text{ kWh.} \end{aligned}$$

### Magnetic effect of electric current

We have learnt about heating effect of electric current. In previous standards, we have studied about magnets and magnetic lines of force. However, it will be interesting to see if an electric current and magnetic field are related to each other.



#### Try this

Connect the circuit as shown in figure 4.5. Connect a copper wire, thicker and straight as compared to the connecting wires, between A and B. Keep a magnetic needle adjacent to the wire. Keep the plug key open in the circuit and observe the direction of the needle. Close the plug key and observe the direction of the needle. What do you notice? Now interchange the connecting wires connected to the cell and observe the direction of the magnetic needle. Do you notice any relation between the direction of current and position of the needle?

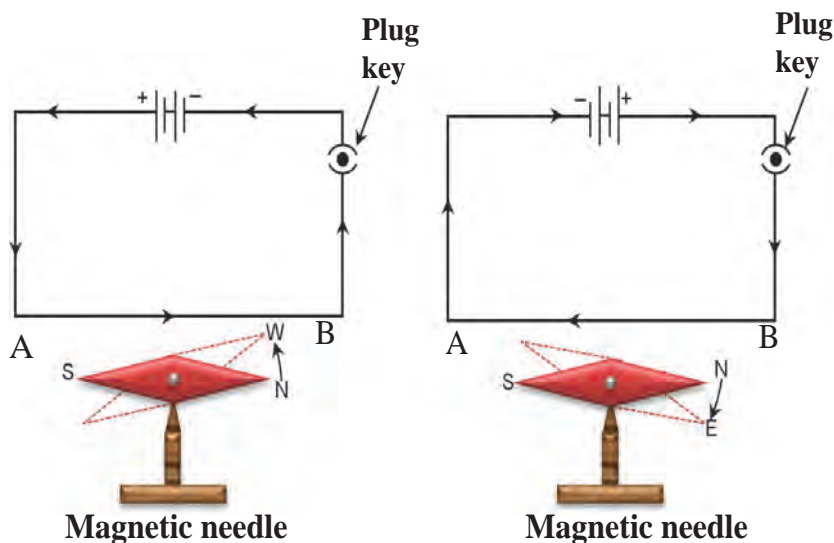

### 4.5 Magnetic effects of a current



What do you learn from this experiment? The magnetic effect is observed because of the current in the wire. This means electricity and magnetism are closely related! On the contrary, if a magnet is moved and kept moving, will we observe any electric effect? Is it not exciting? Therefore, we are going to study magnetic fields and such 'electromagnetic' effects. Finally, we will study the principles, construction and working of electric motor and electric generator.

### Introduction of Scientist



**Hans Christian Oersted (1777-1851)**

As a scientist at the forefront in the 19th century, Hans Christian Oersted played an important role in understanding 'electromagnetism'. He observed, in 1820, that when a current passes through a metal wire, the magnetic needle near the wire turns through a certain angle. He pointed out the relation between electricity and magnetism. Today's advanced technology is developed as a consequence. In his honour, the unit of intensity of the magnetic field is termed as Oersted.



### Try this

Connect the circuit as shown in fig. 4.6 When a large current (approximately 1A or more) flows through the thick copper wire passing through a cardboard, the magnetic needle kept at different points on the cardboard around the wire stands in different directions. Mark these directions with a pencil.

(Discuss with your friends and teachers about the requirement of the current, number of cells, cells of what potential difference, thickness of the wire etc., and then perform the experiment). The direction of the current shown in the circuit is its conventional direction.

What changes are caused by increasing or decreasing current? What do you see when the magnetic needle is kept a little away from the wire? Now, instead of the magnetic needle, spread iron filings on the cardboard and observe. The iron filings arrange themselves in a circular manner around the wire. Why does this happen?

You have studied magnetism and magnetic field in previous standard. The iron filings spread along the magnetic lines of force.

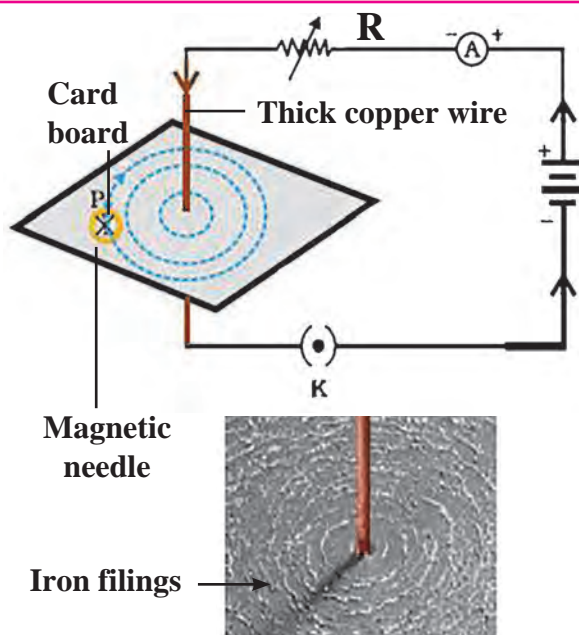

**4.6 Magnetic field produced around the conductor**



### Always remember

A magnetic field is produced around a straight current carrying conductor. If the current is unchanged, this magnetic field reduces as the distance from the wire increases. Therefore, the concentric circles representing the magnetic lines of force are shown bigger and rarefied as the distance from the wire increases. If the current through the wire is increased, the intensity of the magnetic field increases.



## Right hand thumb Rule

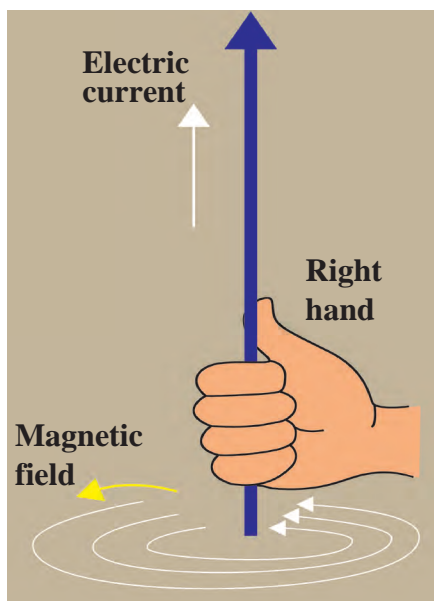

4.7 Right hand thumb Rule

This is a convenient rule for finding out the direction of the magnetic field produced by a current flowing through an electrical conductor. Imagine that you have held the conductor in your right hand in such a way that your thumb points in the direction of the current. Then turn your fingers around the conductor, the direction of the fingers is the direction of the magnetic lines of force (Fig. 4.7).



### Find Out

The right hand thumb rule is called Maxwell's cork-screw rule. What is the cork-screw rule?

## Magnetic field produced by current through a circular loop of a conducting wire.

We learnt about the magnetic lines of force of a magnetic field produced by a current flowing through a straight conductor. What will happen to the magnetic lines of force of the field produced by a current flowing through a loop made by bending the straight wire?

A circuit is completed by connecting various components as shown in the figure 4.8. If the current passes through the loop, magnetic lines of force are produced at each point on the loop. As we go away from the wire, the concentric circles representing the magnetic lines of force will become bigger and bigger.

As we go towards the centre of the loop the circle become so big that its arc can be shown as a straight line.

In fig. 4.8, the magnetic lines of force are shown near the points P and Q only, however, they will be created near each point on the loop. Likewise, each point will produce magnetic field at the centre of the loop.

By making use of the right hand thumb rule, check that every point on the loop contributes the magnetic lines of force at the centre of the loop and these lines of force at the centre of the loop are in the same direction.

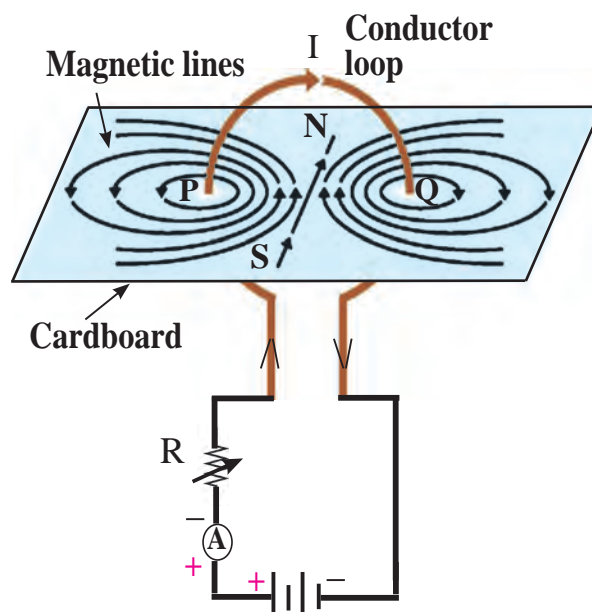

4.8 Magnetic field produced by a current through a loop of conducting wire

The intensity of magnetic field at any point produced by a current flowing through a wire, is dependent on the current, as we have seen in the experiment (fig 4.6 Try this). This means that if there are  $n$  turns in the loop, the magnetic field  $n$  times of that produced by a single loop will be created.

On discussing with your teachers, with their guidance, see if you can perform the above experiment by collecting appropriate materials. The direction of the magnetic field can be determined with the help of a magnetic needle.

### Magnetic field due to a current in a solenoid.

When a copper wire with a resistive coating is wound in a chain of loops (like a spring), it is called solenoid.

Whenever an electric current passes through a solenoid, magnetic lines of force are produced in a pattern as shown in figure 4.9.

You are aware of the magnetic lines of force of a bar magnet. The properties of the magnetic field of a solenoid are very similar to the magnetic field produced by a bar magnet.

One of the open ends of a solenoid acts as a magnetic north pole and the other as the magnetic south pole. The magnetic lines of force inside the solenoid are parallel to each other. What does this mean?

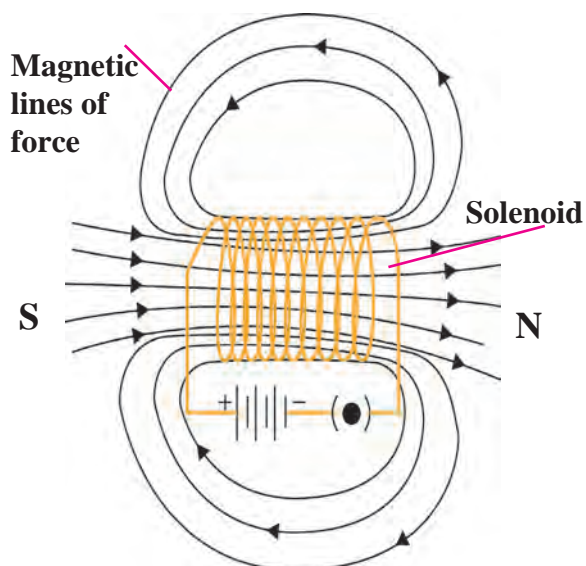

4.9 Magnetic lines of force of a magnetic field produced by a current passing through a solenoid coil.

This means that the intensity of the magnetic field within the solenoid is uniform everywhere, i.e. the magnetic field in a solenoid is uniform.

### Force acting on current carrying conductor in a magnetic field



#### Try this

**Materials:** Flexible copper wire, stand, electric cell, a horse shoe magnet with a strong magnetic field.

**Procedure :** Using the stand, fix the copper wire so that it passes through the poles of the horse shoe magnet as shown in the figure 4.10. Connect the circuit as well. What do you observe?

Whenever a current is not flowing through the wire, it remains straight (position A). When the current flows from top to bottom, the wire bends and comes into position C.

If the current direction is reversed, i.e. it flows from the bottom to the top end, the wire bends but comes in the position B. This means the direction of the force on the wire is perpendicular to both the magnetic field and the direction of the current.

Here, the direction of magnetic field is from N to S, (H). In this experiment it is noted that whenever current flows through a conductor in the presence of magnetic field a force is exerted on the conductor. If the direction of the current is reversed, the direction of the force also gets reversed. If the magnet is kept reversed, i.e. its south pole is brought at the position of its North pole and its North pole brought to the position of its south pole, what will happen?

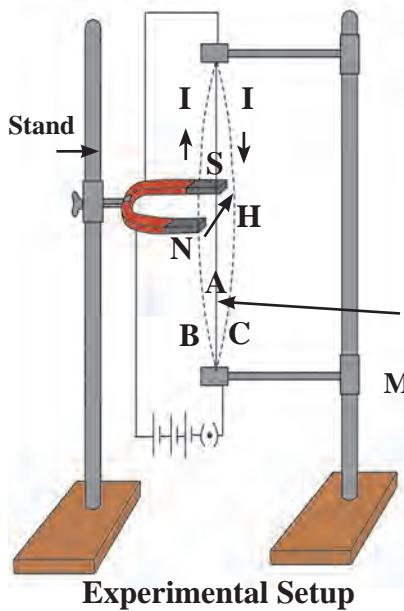

The above experiment clearly shows that a force is exerted on the current carrying conductor. The direction of this force depends on both the direction of the current and the direction of the magnetic field.

Experimentally, it is possible to show that this force is maximum when the direction of the current is perpendicular to the direction of the magnetic field. How will you do this?

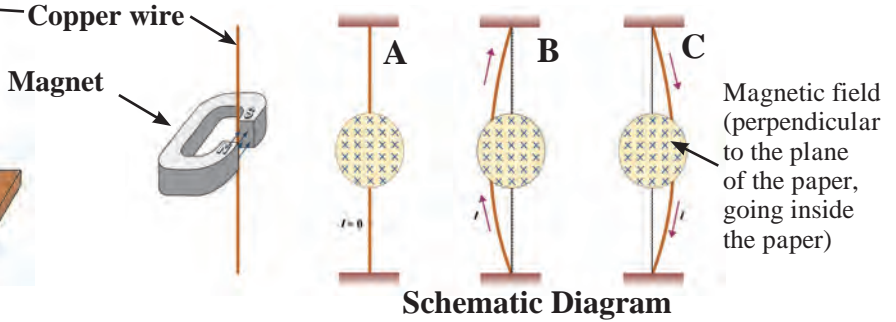

#### 4.10 Force acting on a current carrying conductor in the presence of a magnetic field

##### Fleming's left hand rule

In the above experiment we considered the direction of the electric current and the direction of the magnetic field and found that the direction of the force exerted is perpendicular to both. There is a simple rule relating these three directions. This rule is called Fleming's left hand rule. According to this rule, the left hand thumb, index finger, and the middle finger are stretched so as to be perpendicular to each other. If the index finger is in the direction of the magnetic field, and the middle finger points in the direction of the current, then the direction of the thumb is the direction of the force on the conductor.

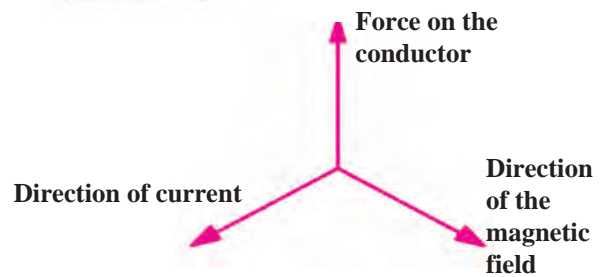
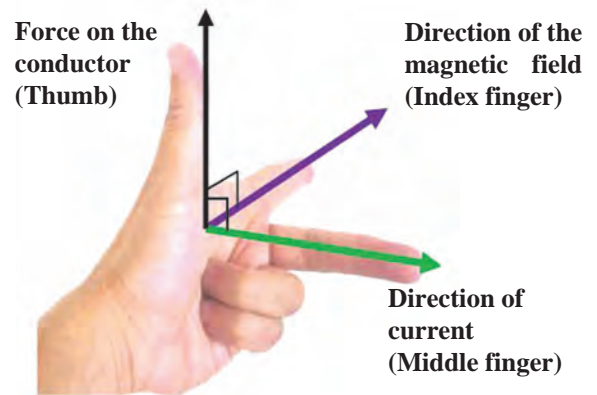

**Try this.**

Determine the direction of the force on the wire in the above experiment and verify your finding.

#### 4.11 Fleming's left hand rule

##### Electric Motor

You know various forms of energy. You also know that energy can change its form. A device changing electrical energy into mechanical energy is known as electric motor. Around us, in our day-to day life, an electric motor is a boon. It is used in fans, refrigerators, mixers, washing machines, computers, pumps, etc. How does this motor work?



#### 4.12 Electric motor in daily use

The electric motor consists of rectangular loop of copper wire having resistive coating. As shown in the figure, it is placed between the north pole and south pole of a magnet (such as a horse shoe magnet) in such a way that its branches AB and CD are perpendicular to the direction of magnetic field. The two ends of the loop are connected to the two halves (X and Y) of the split ring. The two halves of the ring have resistive coating on their inner surfaces and are tightly fitted on the axle. The two halves of the split ring, X and Y, have their outer conducting surfaces in contact with the two stationary carbon brushes, (E and F), respectively.

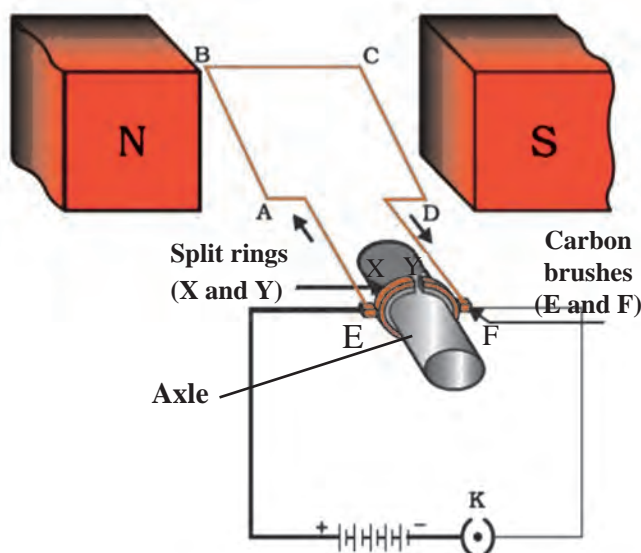

### 4.13 Electric motor: Principle and Working

When the circuit is completed as shown in the figure, the current flows in the branch AB of the loop from A to B through the carbon brushes E and F. Since the direction of the magnetic field is from north pole to south pole, according to the Fleming's left hand rule, a force is exerted on the branch AB and pushes it down. The current in the CD branch is in a opposite direction to that in the AB branch, and therefore, a force is exerted on the branch CD in upward direction. Thus, the loop and the axle start rotating in an anticlockwise direction. After half rotation, the two halves of the split ring X and Y come in contact with carbon brushes F and E, respectively, and the current in a loop starts flowing in the direction DCBA. Therefore, a force is exerted on the branch DC in downward direction and on the branch BA in the upward direction, and the loop continues to rotate in the anticlockwise direction. Thus, the current in the loop is reversed after each half rotation and the loop and the axle continue to rotate in the anticlockwise direction.

Commercial motors run on the same principle, but practical changes are made in their construction; you will learn that later.



#### Find Out

Why are carbon brushes used? How do these work? In order to find answers to such questions, visit a nearby workshop and try to understand the construction of an electric motor.

### Electromagnetic Induction

We have seen in the previous section that if we keep an electric conductor in a magnetic field such that direction of the current flowing through the conductor is perpendicular to the magnetic field, then a force is exerted on the conductor. Because of this, the conductor moves. But if an electric conductor is moving in a magnetic field or the magnetic field around a stationary conductor is changing, what will happen? In order to find out an answer to this question, research was done by the great scientist Michael Faraday. In the year 1831 Faraday showed that an electric current can be produced in a conductor with the help of a moving magnet.



## Galvanometer

Galvanometer is a sensitive device which works on the same principle as that of an electric motor that we have studied earlier. We can make some electrical measurements with it. A coil is positioned between the pole pieces of a magnet in such a way that the pointer on the galvanometer dial is connected to it. When a small current (for example 1 mA) flows through the coil, the coil will rotate. The rotation will be proportional to the current. Voltmeter and Ammeter also work on the same principle. In galvanometer, the pointer deflects on both the sides of the zero mark depending on the direction of the current.



### 4.14 Galvanometer

Collect the material as shown in figure 4.15. Complete the circuit by connecting the galvanometer. Keep the bar magnet erect in such a way that its north or south pole is just below the copper wire. Now if the wire is kept moving from A  $\longrightarrow$  B, the pointer of the galvanometer gets deflected. This is called Faraday's electromagnetic induction. Now move the magnet with the wire fixed. The Galvanometer pointer still gets deflected.

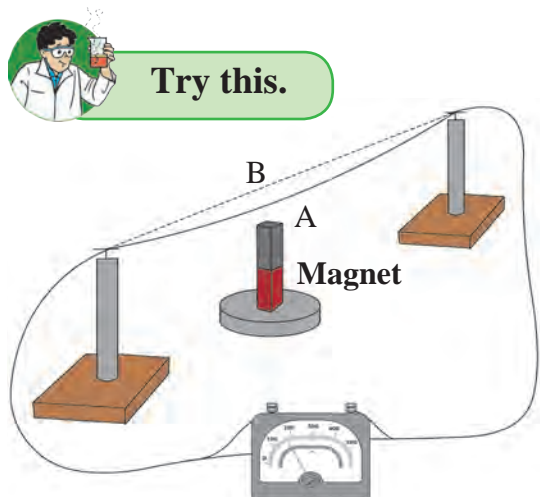

### 4.15 If a conducting wire is kept moving in a magnetic field, a current is produced in it.



**Try this.**

Complete the circuit as shown in figure 4.16a. Discuss about and select the components as required. In this experiment, if we open the plug key and make the current zero in the coil, the pointer of the Galvanometer deflects to a side and quickly comes back to zero. If the current in the coil is started again, the pointer again deflects to the other side and then returns quickly to zero.

Now when the electrical current is flowing through the solenoid coil and the solenoid coil is displaced with respect to the coil, the current is still produced in the coil.

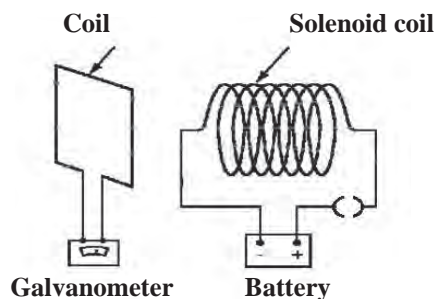

### 4.16 (a) When the current in the solenoid coil is switched on or off

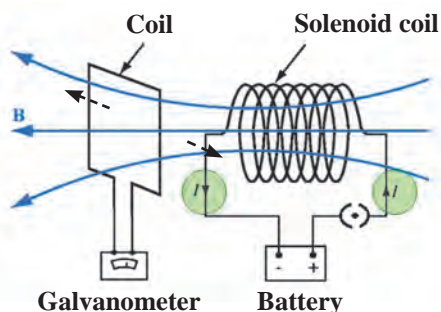

### 4.16 (b) when a current is passing through the solenoid coil and the coil is displaced laterally with respect the coil

What can be inferred from these two experiments?

Even if the solenoid coil is kept stationary, a change in current in the solenoid coil produces a current in the coil. If the solenoid coil is moved towards or away from the coil, we see a deflection in the Galvanometer (fig 4.16c) Also, the faster is the displacement of the solenoid, larger is the deflection of the Galvanometer pointer. If the current in the solenoid coil is changed, a current is produced in the coil or if the solenoid coil is moved towards the coil, then also a current is produced in the coil.

**Faraday’s law of induction:**

If a current is switched on or off in the solenoid coil, a current is induced in the coil. Such as induction is also observed when the current in the solenoid coil is increased or decreased. Current is induced in the coil when it is moved aside from front of the solenoid. From these experiments it is understood that whenever the number of magnetic lines of force passing through the coil changes, current is induced in the coil. This is known as Faraday’s law of induction. The current produced in the coil is called the induced current.

**Fleming’s right hand rule :**

When will the induced current in the electrical conductor (coil) be maximum? It will be maximum when the direction of motion of the electric conductor is perpendicular to the magnetic field. In order to show the direction of the induced current, Fleming’s right hand rule is very useful. Stretch the thumb, the index finger and the middle finger in such a way that they will be perpendicular to each other. In this position, the thumb indicates the direction of motion of the conductor, the index finger the direction of the magnetic field, and the middle finger shows the direction of the induced current. This rule is known as Fleming’s right hand rule (fig 4.17).

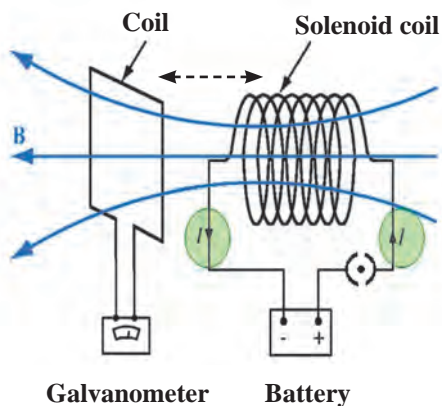

**4.16 c) When a current passing through the solenoid coil and the solenoid coil is displaced longitudinally with respect to the coil**

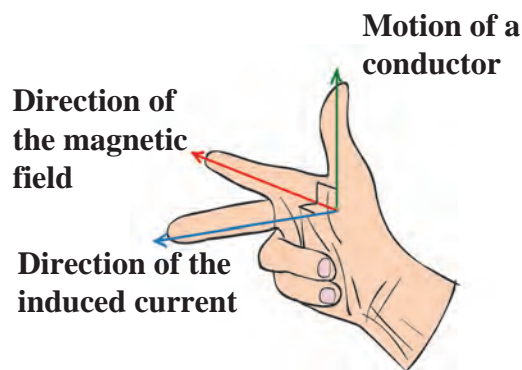

**Motion of a conductor**

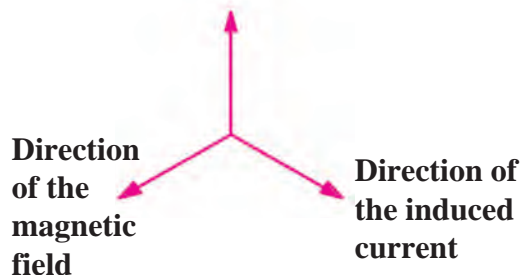

**4.17 Fleming’s right hand rule**

**Introduction to Scientist**

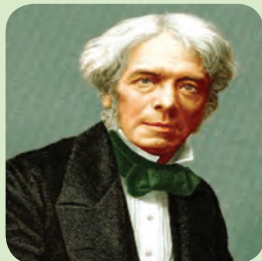

Michael Faraday (1791-1867) was an experimental scientist. He was not formally educated. Teenager Michael started working in a bookbinding shop. While reading books there, he got interested in science. Sir Humphrey Davy appointed him as a laboratory assistant in the Royal Institute London. There he discovered the laws of electromagnetic induction and the laws of electrolysis. Several Universities offered him honorary degree, but Faraday refused to accept such honours.

## Alternating current (AC) and Direct Current (DC)

So far we have learnt about a non oscillatory current flowing in one direction, in a circuit, from the cell to the cell. Such a current is called a direct current (DC) as against a current changing in magnitude and direction after equal intervals of time which is called alternating current (AC).

The direct current can increase, can be stable, or can reduce also, but it is not oscillatory. This is shown graphically in the figure. Alternating current is oscillatory. As shown in the graph (fig 4.19), it increases to a maximum, then reduces to zero and increases to maximum in the other direction and again reduced to zero. (in the figure, magnitudes like -1, -2 have been used to show the reverse direction). The oscillation of the alternating current occurs in a sinusoidal manner with time and hence is shown by the symbol  $\sim$ . Direct current flows in one direction, but the alternating current flows in periodic manner, in one cycle, in forward and reverse directions.

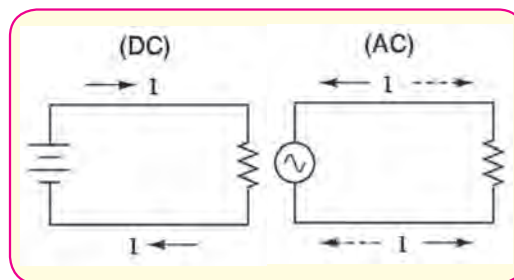

4.18 AC current and DC current

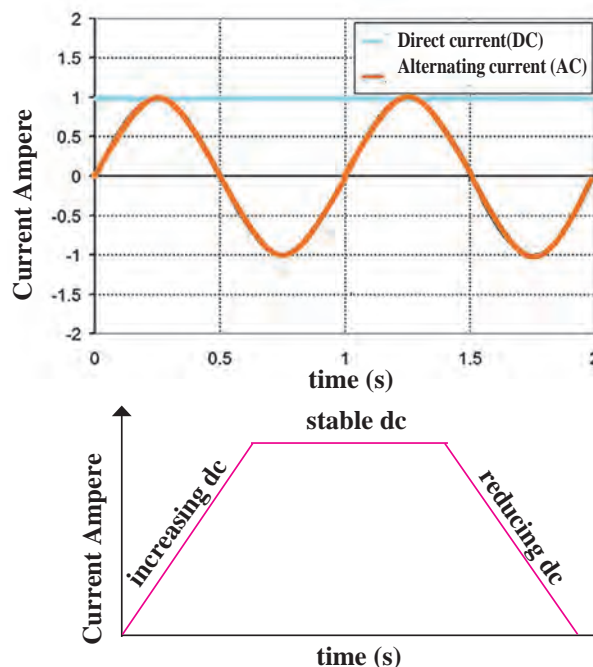

4.19 Alternating current and Direct current (Graphical)

In India, in the power stations generating electricity, one cycle changes in  $\frac{1}{50}$  second i.e. the frequency of AC is 50 Hz (50 cycles per second). When the electric power is transmitted over a long distance, it is beneficial to have it in AC form as it results into minimum power loss during transmission. The home supply is of alternating current (AC). We have learnt in the previous class about the precautions to be taken while using the electricity.

## Electric Generator

We have seen the experiments based on electromagnetic induction. The current produced in these experiments was of very small magnitude. But the same principle can be harnessed for the use of mankind to produce large current. Here, mechanical energy is used to rotate the current carrying coil in a magnetic field, around an axle, thereby producing electricity.

Fig 4.20 shows a copper wire coil ABCD, kept between the two pole pieces of a magnet. The two ends of the coil are connected to the conducting rings  $R_1$  and  $R_2$  via carbon brushes. Both the rings are fixed to the axle, but there is a resistive coating in between the ring and the axle. The axle is rotated with the help of a machine from outside. Because of this, the coil ABCD starts rotating. The stationary carbon brushes  $B_1$  and  $B_2$  are connected to a galvanometer, which shows the direction of current in the circuit. Upon rotating the axle, the branch AB goes up and the branch CD goes down (i.e. the coil ABCD rotates clockwise).

According to Fleming's right hand rule, electric current is produced in the branches AB and CD in the direction.  $A \rightarrow B$  and  $C \rightarrow D$ . Thus, the current flows in the direction  $A \rightarrow B \rightarrow C \rightarrow D$  (as shown by arrows in the figure). In the external circuit, the current flows from  $B_2$  to  $B_1$  through the galvanometer. If instead of one loop coil, a coil consisting of several turns is used, the current of magnitude several times flows. After half rotation, the branch AB takes the place of branch CD and the branch CD takes the position of the branch AB. Therefore, the induced current goes as  $D \rightarrow C \rightarrow B \rightarrow A$ .

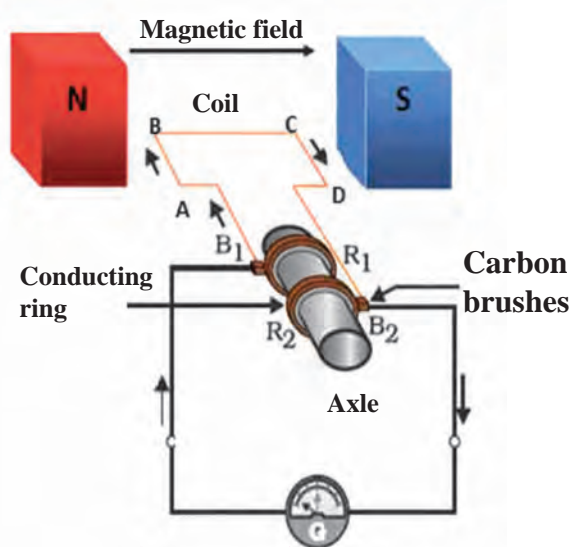

4.20 Electric generator

But, the branch BA is always in contact with the brush  $B_1$  and branch DC in the contact with  $B_2$ . Hence, in the external circuit current flows from  $B_1$  to  $B_2$  i.e. opposite to the previous half rotation. This repeats after every half rotation and alternating current is produced. This is what is called an AC generator .

**What will be required to make a DC generator?** The DC does not change the direction in the external circuit. To achieve this, a split ring is fixed on the axle like a split ring used in electric motor. Because of this arrangement, the branch of the coil going upwards is always in contact with one brush and the branch going downwards is always in contact with the other brush. Hence, the current flows in one direction in the external circuit. This is why this generator is called as a DC generator.



Use your brain power !

Draw the diagram of a DC generator. Then explain as to how the DC current is obtained .

## Exercise

- Tell the odd one out. Give proper explanation.**
  - Fuse wire, bad conductor, rubber gloves, generator.
  - Voltmeter, Ammeter, galvanometer, thermometer.
  - Loud speaker, microphone, electric motor, magnet.
- Explain the construction and working of the following. Draw a neat diagram and label it.**
  - Electric motor
  - Electric Generator(AC)
- Electromagnetic induction means-**
  - Charging of an electric conductor.
  - Production of magnetic field due to a current flowing through a coil.
- Generation of a current in a coil due to relative motion between the coil and the magnet.
- Motion of the coil around the axle in an electric motor.
- Explain the difference : AC generator and DC generator.**
- Which device is used to produce electricity? Describe with a neat diagram.**
  - Electric motor
  - Galvanometer
  - Electric Generator (DC)
  - Voltmeter
- How does the short circuit form? What is its effect?**



**7. Give Scientific reasons.**

- Tungsten metal is used to make a solenoid type coil in an electric bulb.
- In the electric equipment producing heat e.g. iron, electric heater, boiler, toaster etc. an alloy such as Nichrome is used, not pure metals.
- For electric power transmission, copper or aluminium wire is used.
- In practice the unit kWh is used for the measurement of electrical energy, rather than joule.

**8. Which of the statement given below correctly describes the magnetic field near a long, straight current carrying conductor?**

- The magnetic lines of force are in a plane, perpendicular to the conductor in the form of straight lines.
- The magnetic lines of force are parallel to the conductor on all the sides of conductor.
- The magnetic lines of force are perpendicular to the conductor going radially outward.
- The magnetic lines of force are in concentric circles with the wire as the center, in a plane perpendicular to the conductor.

**9. What is a solenoid? Compare the magnetic field produced by a solenoid with the magnetic field of a bar magnet. Draw neat figures and name various components.**

**10. Name the following diagrams and explain the concept behind them.**

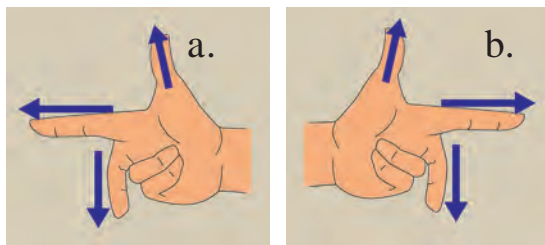

**11. Identify the figures and explain their use.**

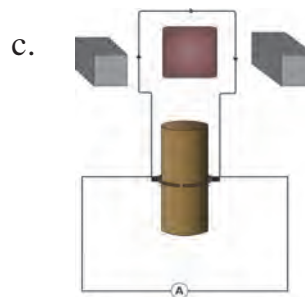
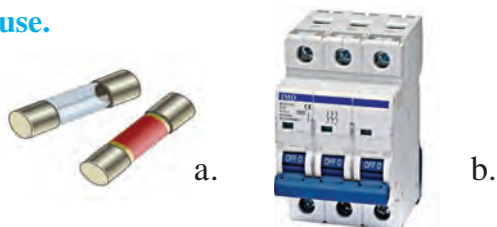

**12. Solve the following example.**

- Heat energy is being produced in a resistance in a circuit at the rate of 100 W. The current of 3 A is flowing in the circuit. What must be the value of the resistance? **(Ans : 11 Ω)**
- Two tungsten bulbs of wattage 100 W and 60 W power work on 220 V potential difference. If they are connected in parallel, how much current will flow in the main conductor? **(Ans : 0.72A)**
- Who will spend more electrical energy? 500 W TV Set in 30 mins, or 600 W heater in 20 mins? **(Ans : TV Set)**
- An electric iron of 1100 W is operated for 2 hrs daily. What will be the electrical consumption expenses for that in the month of April? (The electric company charges Rs 5 per unit of energy). **(Ans : Rs 330)**

**Project**

Under the guidance of your teachers, make a 'free-energy generator'.



## 5. Heat



- Latent heat
- Anomalous behaviour of water
- Specific heat capacity
- Regelation
- Dew point and humidity



### Can you recall?

1. What is the difference between heat and temperature?
2. What are the different ways of heat transfer?

In the previous standard, we have learnt about heat and different types of heat transfer. We have also performed few experiments related to expansion and contraction of solids, liquids and gases. We have learnt about the difference between heat and temperature. We have also seen how temperature is measured using a thermometer.

Concepts like latent heat of phase transformation, anomalous behaviour of water, dew point, humidity, specific heat capacity etc. are related to certain phenomena experienced by us in our day-to-day life. Let us learn more about these concepts.

### Latent heat



### Try this

1. Take a few pieces of ice in a glass beaker. As shown in figure 5.1.
2. Insert the bulb of a thermometer in ice and measure its temperature.
3. Put the beaker on a stand and heat the ice using a burner.
4. Record the temperature using the thermometer after every minute.
5. As the ice is heated, it starts melting. Stir the mixture of ice and water.
6. Continue the heating even after ice starts melting.
7. Draw a graph of temperature versus time.

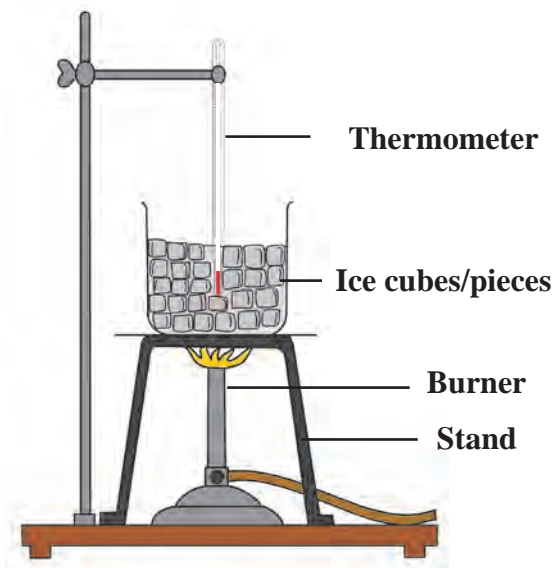

5.1 Latent heat

You will observe that the temperature of the mixture remains  $0^{\circ}\text{C}$  till the ice melts completely. If we continue heating, even after conversion of all the ice into water, the temperature of water starts rising and reaches  $100^{\circ}\text{C}$ . At this temperature water starts converting into steam. The temperature of water remains constant at  $100^{\circ}\text{C}$  till all water converts into steam. The graph of temperature versus time is shown in figure 5.2.

In this graph, line AB represents conversion of ice into water at constant temperature. When ice is heated it melts at  $0^{\circ}\text{C}$  and converts into water at this constant temperature. The ice absorbs heat energy during this transition and the absorption of energy continues till all the ice converts into water.

The temperature remains constant during this transition. This constant temperature, at which the ice converts into water is called the melting point of ice.

Thus, during transition of solid phase to liquid, the object absorbs heat energy, but its temperature does not increase. This heat energy is utilised for weakening the bonds between the atoms or molecules in the solid and transform it into liquid phase. The heat energy absorbed at constant temperature during transformation of solid into liquid is called the latent heat of fusion.

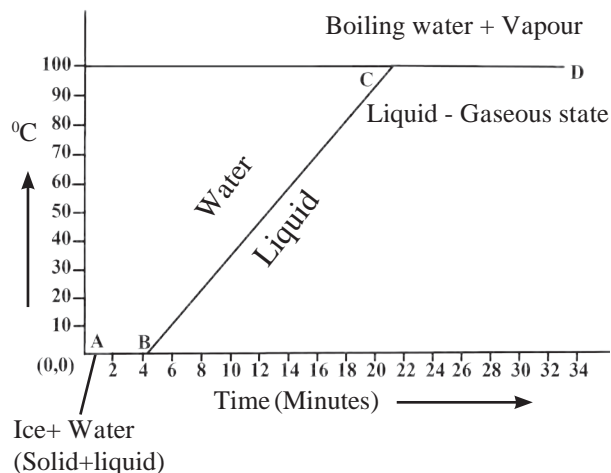

**5.2 Temperature vs Time Graph**

**The amount of heat energy absorbed at constant temperature by unit mass of a solid to convert into liquid phase is called the specific latent heat of fusion.**

Once all the ice is transformed into water, the temperature of water starts rising. It increases up to 100°C. Line BC in the graph represents rise in temperature of water from 0 °C to 100 °C. Thereafter, even though heat energy is supplied to water, its temperature does not rise. The heat energy is absorbed by water at this temperature and used to break the bonds between molecules of the liquid and convert the liquid into gaseous state. Thus, during transformation from liquid phase to gas phase, heat energy is absorbed by the liquid, but its temperature does not change. The constant temperature at which the liquid transforms into gaseous state is called the boiling point of the liquid. The heat energy absorbed at constant temperature during transformation of liquid into gas is called the latent heat of vapourization.

**The amount of heat energy absorbed at constant temperature by unit mass of a liquid to convert into gaseous phase is called the specific latent heat of vapourization.**

Different substances have different melting points and boiling points. The values of melting point, boiling point and latent heat depend on atmospheric pressure.

Substance	Melting point °C	Boiling point °C	Specific latent heat of fusion		Specific latent heat of vaporization	
			kJ/kg	cal/g	kJ/kg	cal/g
Water/ Ice	0	100	333	80	2256	540
Copper	1083	2562	134	49	5060	1212
Ethyl alcohol	-117	78	104	26	8540	200
Gold	1063	2700	144	15.3	1580	392
Silver	962	2162	88.2	25	2330	564
Lead	327.5	1749	26.2	5.9	859	207



**Use your brain power !**

1. Is the concept of latent heat applicable during transformation of gaseous phase to liquid phase and from liquid phase to solid phase?
2. Where does the latent heat go during these transformations?

## Regelation

You may have seen the preparation of an ice-ball. First, an ice slab is shredded and then the shredded ice is pressurised around the tip of a stick to prepare the ice-ball. How does the shredded ice convert into solid ice ball? If two small pieces of ice are taken and pressed against each other for a while, they stick to each other. Why does this happen?



### Try this

Take a small slab of ice, a thin wire, two identical weights.

### Activity:

1. Put a slab of ice on a stand as shown in Figure 5.3.
2. Hang two equal weights to the two ends of a metal wire and put the wire on the slab as shown in the figure.

What do you observe?

It is observed that the wire gradually penetrates the ice slab. After some time, the wire comes out of the lower surface of the ice slab. However, the ice slab does not break. The phenomenon in which the ice converts to liquid due to applied pressure and then re-converts to ice once the pressure is removed is called regelation.

The melting point of ice becomes lower than  $0^{\circ}\text{C}$  due to pressure. This means that at  $0^{\circ}\text{C}$ , the ice gets converted into water. As soon as the pressure is removed, the melting point is restored to  $0^{\circ}\text{C}$  and water gets converted into ice again.

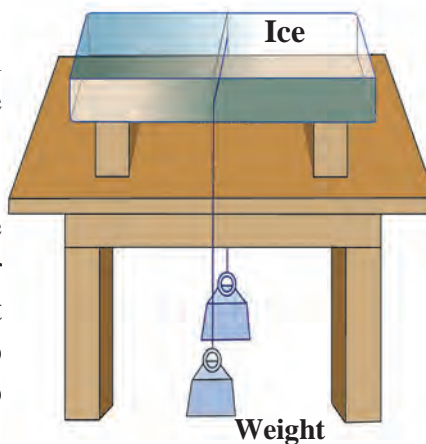

5.3 Regelation



### Use your brain power !

1. In the above experiment, the wire moves through the ice slab. However, the ice slab does not break. Why?
2. Is there any relationship of latent heat with the regelation?
3. You know that as we go higher than the sea level, the boiling point of water decreases. What would be effect on the melting point of solid?



### Can you tell?

We feel that some objects are cold, and some are hot. Is this feeling related in some way to our body temperature?

## Anomalous behaviour of water

In general, when a liquid is heated up to a certain temperature, it expands, and when cooled it contracts. Water, however, shows a special and exceptional behaviour. If we heat water from  $0^{\circ}\text{C}$  up to  $4^{\circ}\text{C}$ , it contracts instead of expanding. At  $4^{\circ}\text{C}$  its volume is minimum (due to contraction). If the water is heated further, it expands and its volume increases. The behaviour of water between its temperature from  $0^{\circ}\text{C}$  to  $4^{\circ}\text{C}$  is called anomalous behaviour of water.

If 1 kg of water is heated from  $0^{\circ}\text{C}$  and its volume is plotted as a function of temperature, we get the graph, shown in fig 5.4. At  $4^{\circ}\text{C}$ , the volume of water is minimum. It means that the density of water is maximum at  $4^{\circ}\text{C}$ .



### Study of anomalous behaviour of water using Hope's apparatus.

The anomalous behaviour of water can be studied with Hope's apparatus. In Hope's apparatus, a flat bowl is attached to a cylindrical container as shown in figure 5.5. There is provision to attach thermometers above (to measure temperature  $T_2$ ) and below (to measure temperature  $T_1$ ) the flat bowl on the cylindrical container. Water is filled in the cylindrical container and a mixture of ice and salt (freezing mixture) is put in the flat bowl.

During the study of anomalous behaviour of water using Hope's apparatus, temperature  $T_1$  and  $T_2$  are recorded after every 30 seconds.

The temperatures are plotted on the Y-axis and the time in minutes on the X-axis. The graph is shown in figure 5.6. The graph shows that initially, both the temperatures  $T_1$  and  $T_2$  are identical. However, as time passes, temperature  $T_1$  of water in the lower part of the cylinder decreases fast, while, temperature  $T_2$  of water in the upper part of the cylinder decreases comparatively slowly.

However, once the temperature  $T_1$  of the lower part reaches  $4^\circ\text{C}$ , it remains almost stable at that temperature.  $T_2$  decreases slowly to  $4^\circ\text{C}$ . Thereafter, since  $T_2$  starts changing rapidly, it records  $0^\circ\text{C}$  first and after that the lower thermometer  $T_1$  records  $0^\circ\text{C}$  temperature. The point of intersection of the two curves shows the temperature of maximum density.

How can we explain these observations? Initially, the temperature of water in the middle of cylinder lowers due to freezing mixture in the outer bowl. Since the temperature of water there decreases, its volume decreases, and its density increases. The water with higher density moves downwards. Therefore, the lower thermometer  $T_1$  shows rapid fall in temperature and this continues till the temperature of water becomes equal to  $4^\circ\text{C}$ . When the temperature of water starts decreasing below  $4^\circ\text{C}$ , its volume increases, and density decreases. It, therefore, moves in the upward direction. The temperature of water in upper part ( $T_2$ ), therefore, decreases rapidly to  $0^\circ\text{C}$ . The temperature of water in the lower part ( $T_1$ ), however, remains at  $4^\circ\text{C}$  for some time and then decreases slowly to  $0^\circ\text{C}$ .

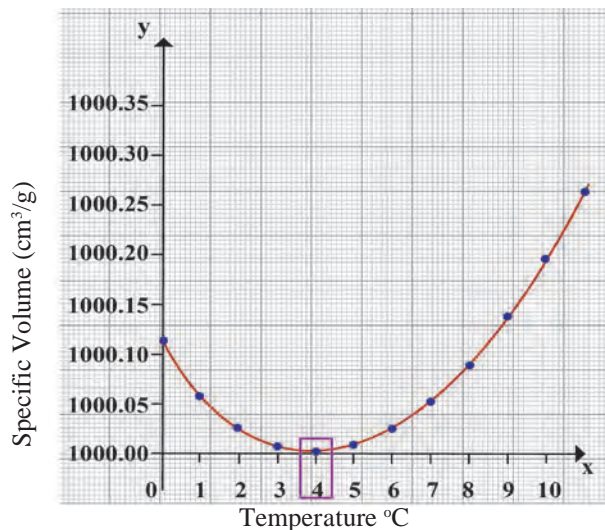

5.4 Graph between the volume and temperature of water

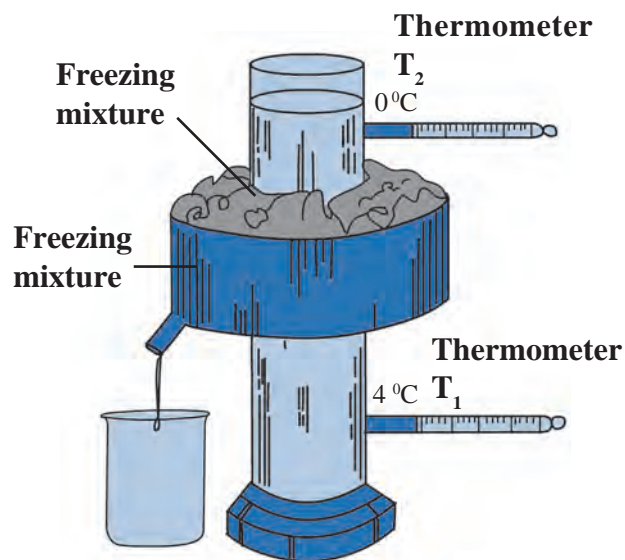

5.5 Hope's Apparatus

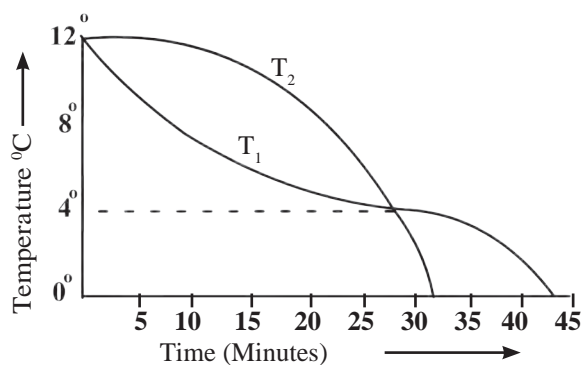

5.6 Time - Temperature Graph

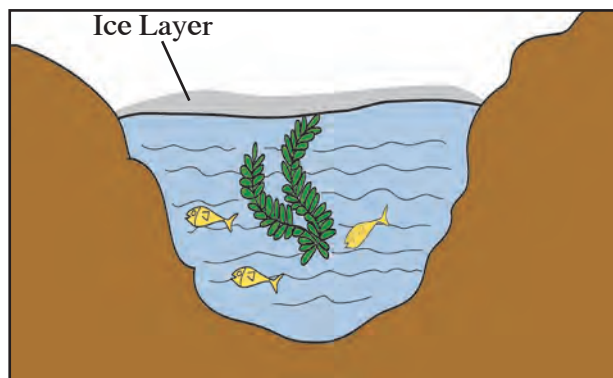

5.7 Aquatic animals in cold regions



Use your brain power !

How will you explain following statements with the help of the anomalous behaviour of water?

1. In regions with cold climate, the aquatic plants and animals can survive even when the atmospheric temperature goes below 0 °C (See figure 5.7).
2. In cold regions in winter the pipes for water supply break and even rocks crack.

### Dew point and Humidity

About 71% surface of the Earth is covered with water. Due to constant evaporation of water, water vapour is always present in the atmosphere. The amount of water vapour in the atmosphere helps us to understand the state of daily weather. The presence of water vapour in the air makes it moist. The moisture in the atmosphere is called humidity.

For a given volume of air, at a specific temperature, there is a limit on how much water vapour the air can contain. If the amount exceeds this limit, the excess vapour converts into water droplets. When the air contains maximum possible water vapour, it is said to be saturated with vapour at that temperature. The amount of vapour needed to saturate the air depends on temperature of the air. If air temperature is low, it will need less vapour to saturate the air. For example, if temperature of air is 40 °C, it can contain 49 grams of water vapour per kilogram of dry air without condensation. If the amount of vapour exceeds this limit, the additional vapour will condense. However, if the temperature of air is 20 °C, it can contain only 14.7 grams of water vapour per kilogram of dry air without condensing. If the vapour contained in air is less than the maximum limit, then the air is said to be unsaturated.

**Suppose unsaturated air at a certain temperature is taken and its temperature is decreased, a temperature is reached at which the air becomes saturated with vapour. This temperature is called the dew point temperature.**

The vapour content in the air is measured using a physical quantity called absolute humidity. The mass of vapour present in a unit volume of air is called absolute humidity. Generally absolute humidity is measured in kg/m<sup>3</sup>.

The feeling of humid or dry nature of air not only depends on the amount of vapour in the air, but it also depends on how close that amount is for making the air saturated with vapour. It means that it depends on temperature of the air also.

The ratio of actual mass of vapour content in the air for a given volume and temperature to that required to make the air saturated with vapour at that temperature is called the relative humidity.

$$\% \text{ Relative humidity} = \frac{\text{actual mass of water vapour content in the air in a given volume}}{\text{mass of vapour needed to make the air saturated in that volume}} \times 100$$

The relative humidity at the dew point is 100%. If the relative humidity is more than 60% we feel that the air is humid. If the relative humidity is less than 60%, we feel that the air is dry.

During winter season, you may have observed a white trail at the back of a flying plane in a clear sky. As the plane flies, the vapour released by the aeroplane engine condenses and forms clouds. If the surrounding air is having more relative humidity, it takes a long time for the white trail, formed by condensation of the vapour, to disappear. If relative humidity of the surrounding air is less, either the size of the white trail may be small or it may not even get formed.



### Try this.

1. Take a bottle of cold water out of a refrigerator and keep it outside for a while. Observe the outer surface of the bottle.
2. Drops of water can be observed on the outer surface of bottle. In the same way, if we observe the leaves of plants/grass or window-glass of a vehicle in the early morning we see water droplets collected on the surface.

Through these two observations, we sense the presence of water vapour in the atmosphere. When air cools, due to decrease in temperature it becomes saturated with water vapour. As a result, the excess water vapour gets converted into tiny droplets. The dew-point temperature is decided by the amount of vapour in the air.

### Unit of heat

The units of heat are Joule (J) in SI units, cal (calorie) in cgs units.

The amount of heat necessary to raise temperature of 1 g of water by 1 °C from 14.5 °C to 15.5 °C is called one cal heat.

Similarly, the amount of heat necessary to raise the temperature of 1 kg of water by 1 °C from 14.5 °C to 15.5 °C is called one kcal heat.

It is clear that (1 kcal= 1000 cal).



### Always remember

If we heat 1 kg of water by 1°C in different temperature range than 14.5 °C to 15.5 °C, the amount of heat required will be slightly different. It is, therefore, essential to define a specific temperature range while defining the unit of heat. Calorie and Joule are related by following relation: 1 cal = 4.18 Joule



### Introduction to Scientist

James Prescott Joule (1818-1889) : He was the first person to show that the kinetic energy of tiny particles of matter appears as heat energy and also that energy can be converted from one form to another. Conversion of heat energy to work gives the first law of thermodynamics. The unit of heat is called Joule (J) after him.

## Specific Heat Capacity



**Try this.**

**Material :** A tray with thick layer of wax, solid spheres of iron, lead and copper of equal mass, burner or spirit lamp, large beaker.

### Procedure :

1. Take three spheres of iron, copper and lead of equal mass (Fig. 5.8)
2. Put all the three spheres in boiling water in the beaker for some time.
3. Take the three spheres out of the water. All the spheres will be at temperature 100 °C. Put them immediately on the thick slab of wax.
4. Note, the depth that each of the sphere goes into the wax.

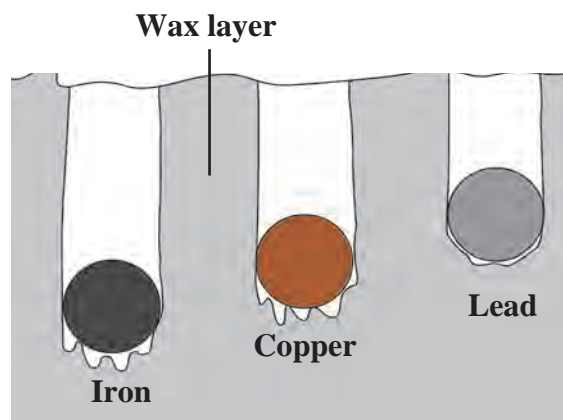

### 5.8 Specific heat capacity of metals

The sphere which absorbs more heat from the water will give more heat to wax. More wax will thus melt and the sphere will go deeper in the wax. It can be observed that the iron sphere goes deepest into the wax. Lead sphere goes the least and copper sphere goes to intermediate depth. This shows that for equal rise in temperature, the three spheres have absorbed different amounts of heat. This means that the property which determines the amount of heat absorbed by a sphere is different for the three spheres. This property is called the specific heat capacity.

**The amount of heat energy required to raise the temperature of a unit mass of an object by 1 °C is called the specific heat of that object.**

The specific heat capacity is denoted by letter 'c'. The SI unit of specific heat is J/ °C kg, and the CGS unit is cal/g °C.

S. No.	Substance	Specific heat (cal/g °C)	S. No.	Substance	Specific heat (cal/g °C)
1.	Water	1.0	5.	Iron	0.110
2.	Paraffin	0.54	6.	Copper	0.095
3.	Kerosene	0.52	7.	Silver	0.056
4.	Aluminium	0.215	8.	Mercury	0.033

### 5.9 Specific heat capacity of some substances

If specific heat of an object is 'c', the mass of the object is 'm' and if the temperature of the object is raised by  $\Delta T$  °C, the heat energy absorbed by the object is given by,

$$m \times c \times \Delta T.$$

In the same way if specific heat of an object is 'c', the mass of the object is 'm' and if the temperature of the object is decreased by  $\Delta T$  °C, then the heat energy lost by the object will be,

$$m \times c \times \Delta T.$$



**Heat Exchange** If heat is exchanged between a hot and cold object, the temperature of the cold object goes on increasing due to gain of energy and the temperature of the hot object goes on decreasing due to loss of energy. The change in temperature continues till the temperatures of both the objects attain the same value. In this process, the cold object gains heat energy and the hot object loses heat energy. If the system of both the objects is isolated from the environment by keeping it inside a heat resistant box (meaning that the energy exchange takes place between the two objects only), then no energy can flow from inside the box or come into the box (fig 5.10). In this situation, we get the following principle

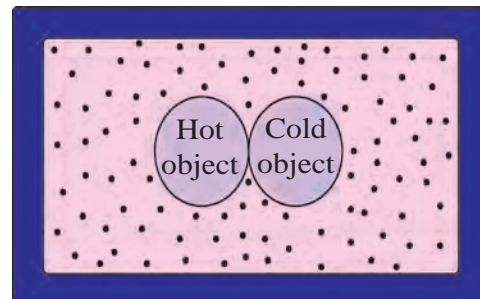

**5.10 Box of heat resistant material**

**Heat energy lost by the hot object = Heat energy gained by the cold object.** This is called as 'Principle of heat exchange'

**Measurement of specific heat: (mixing method) and calorimeter**

The specific heat of an object can be measured using mixing method. For this calorimeter is used. You have learnt about calorimeter in the previous standard. If a hot solid object is put in the water in a calorimeter, heat exchange between the hot object and the water and calorimeter starts. This continues till the temperatures of the solid object, water and the calorimeter become equal. Therefore,

Heat lost by solid object = heat gained by water in calorimeter + heat gained by the calorimeter.

Here, heat lost by the solid object ( $Q$ ) = mass of the solid object  $\times$  its specific heat  $\times$  decrease in its temperature.

Similarly,

Heat gained by the water ( $Q_1$ ) = mass of the water  $\times$  its specific heat  $\times$  increase in its temperature

Heat gained by the calorimeter ( $Q_2$ ) = mass of the calorimeter  $\times$  its specific heat  $\times$  increase in its temperature.

Heat lost by hot object = Heat gained by calorimeter + Heat gained by water.

$$Q = Q_2 + Q_1$$

Using these equations, if the specific heat of water and the calorimeter are known, the specific heat of the solid object can be calculated.

**ICT :**

Prepare a presentation using videos, pictures, audios, graphs etc. to explain various concepts in this chapter. Collect all such material from the Internet, using Information Technology. Under the guidance of your teachers, arrange a competition of such presentations in your class.

**Solved Examples**

**Example 1:** How much heat energy is necessary to raise the temperature of 5 kg of water from 20 °C to 100 °C.

Given:  $m = 5$  kg,  $c = 1$  kcal/kg °C and change in temperature  $\Delta T = 100 - 20 = 80$  °C

$$\begin{aligned} \text{Energy to be supplied to water} &= \text{energy gained by water} \\ &= \text{mass of water} \times \text{specific heat of water} \times \text{change in temperature of water} \\ &= m \times c \times \Delta T \\ &= 5 \times 80 \text{ °C} \\ &= 400 \text{ kcal} \end{aligned}$$

Hence, the heat energy necessary to raise the temperature of water = 400 kcal.

**Example 2:** A copper sphere of 100 g mass is heated to raise its temperature to 100 °C and is released in water of mass 195 g and temperature 20 °C in a copper calorimeter. If the mass of calorimeter is 50 g, what will be the maximum temperature of water?

**Given:** Specific heat of copper = 0.1 cal/g °C

And so specific heat of calorimeter = 0.1 cal/ g °C

Suppose the copper ball water and the calorimeter attain final temperature T.

Heat lost by solid object = heat gained by water in calorimeter + heat gained by the calorimeter.

Here, heat lost by the copper ball = mass of the copper × specific heat of copper  
× decrease in temperature of the ball

$$Q = 100 \times 0.1 \times (100 - T)$$

Similarly,

Heat gained by the water = mass of the water X its specific heat X increase in its temperature

$$Q_1 = 195 \times 1 \times (T - 20) \quad \text{and}$$

Heat gained by the calorimeter = mass of the calorimeter × its specific heat × increase in its temperature

$$Q_2 = 50 \times 0.1 \times (T - 20)$$

$$Q = Q_1 + Q_2$$

$$100 \times 0.1 \times (100 - T) = 195 \times 1 \times (T - 20) + 50 \times 0.1 \times (T - 20)$$

$$10(100 - T) = 195(T - 20) + 5(T - 20)$$

$$10(100 - T) = 200(T - 20)$$

$$210T = 5000$$

$$T = 23.8 \text{ } ^\circ\text{C}$$

∴ The maximum temperature of water will be 23.8 °C.

**Example 3:** If 80 g steam of temperature 97 °C is released on an ice slab of temperature 0 °C, how much ice will melt? How much energy will be transferred to the ice when the steam will be transformed to water?

**Given:** Latent heat of melting the ice =  $L_{\text{melt}} = 80 \text{ cal/g}$

Latent heat of vaporization of water =  $L_{\text{vap.}} = 540 \text{ cal/g}$

**Solution:** mass of steam =  $m_{\text{steam}} = 80 \text{ g}$

Temperature of steam = 97 °C

Temperature of ice =  $T_{\text{ice}} = 0 \text{ } ^\circ\text{C}$

Heat released during conversion of steam of temperature 97 °C into water of temperature 97 °C =  $m_{\text{steam}} \times L_{\text{vap.}}$

$$= 80 \times 540 \text{ ----- (1)}$$

Heat released during conversion of water of 97 °C into water at 0 °C

$$= m_{\text{steam}} \times \Delta T \times c$$

$$= 80 \times (97 - 0) \times 1 = 80 \times 97 \text{ ----- (2)}$$

Total heat gained by the ice =  $80 \times 540 + 80 \times 97$  from equations (1) and (2)

$$= 80(540 + 97)$$

$$= 80 \times 637 = 50960 \text{ cal.}$$

Some mass, of the ice,  $m_{ice}$  will melt due to this heat gained by the ice, then,

$$m_{ice} \times L_{melt} = 50960 \text{ cal}$$

$$m_{ice} \times 80 = 50960$$

$$m_{ice} = 637 \text{ g}$$

Thus, 637 g ice will melt and 50960 cal kcal will be given to the ice.

**Books are My Friends : Read for more information**

1. A Textbook of heat - J.B. Rajam
2. Heat - V.N Kelkar
3. A Treatise on Heat - Saha and Srivastava

**Exercise**



1. Fill in the blanks and rewrite the sentence.

- a. The amount of water vapour in air is determined in terms of its .....
- b. If objects of equal masses are given equal heat, their final temperature will be different. This is due to difference in their .....
- c. During transformation of liquid phase to solid phase, the latent heat is .....

2. Observe the following graph. Considering the change in volume of water as its temperature is raised from 0 °C, discuss the difference in the behaviour of water and other substances. What is this behaviour of water called?

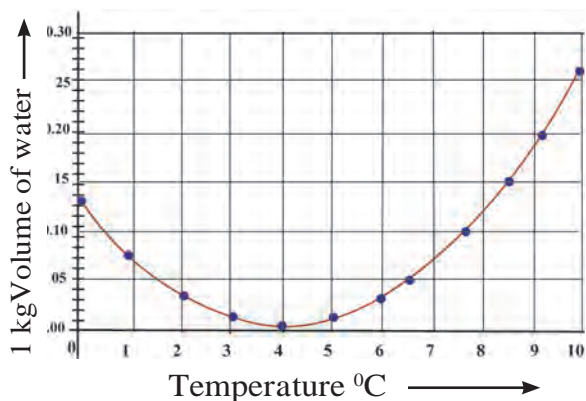

3. What is meant by specific heat capacity? How will you prove experimentally that different substances have different specific heat capacities?
4. While deciding the unit for heat, which temperatures interval is chosen? Why?
5. Explain the following temperature versus time graph.

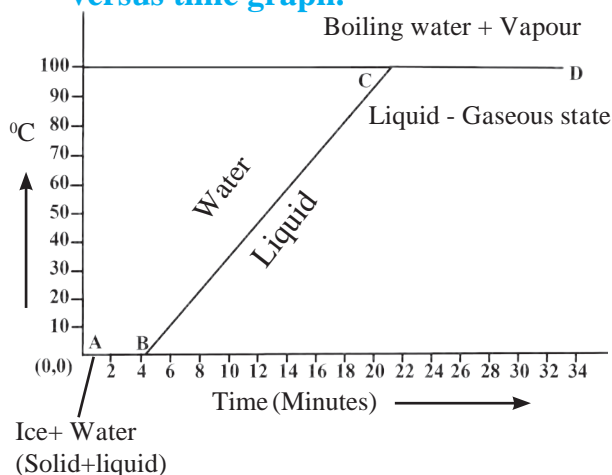

6. Explain the following:

- a. What is the role of anomalous behaviour of water in preserving aquatic life in regions of cold climate?
- b. How can you relate the formation of water droplets on the outer surface of a bottle taken out of refrigerator with formation of dew?
- c. In cold regions in winter, the rocks crack due to anomalous expansion of water.

### 7. Answer the following:

- What is meant by latent heat? How will the state of matter transform if latent heat is given off?
- Which principle is used to measure the specific heat capacity of a substance?
- Explain the role of latent heat in the change of state of a substances?
- On what basis and how will you determine whether air is saturated with vapour or not?

### 8. Read the following paragraph and answer the questions.

If heat is exchanged between a hot and cold object, the temperature of the cold object goes on increasing due to gain of energy and the temperature of the hot object goes on decreasing due to loss of energy.

The change in temperature continues till the temperatures of both the objects attain the same value. In this process, the cold object gains heat energy and the hot object loses heat energy. If the system of both the objects is isolated from the environment by keeping it inside a heat resistant box (meaning that the energy exchange takes place between the two objects only), then no energy can flow from inside the box or come into the box.

- Heat is transferred from where to where?
- Which principle do we learn about from this process?
- How will you state the principle briefly?
- Which property of the substance is measured using this principle?

### 9. Solve the following problems:

- Equal heat is given to two objects A and B of mass 1 g. Temperature of A increases by 3 °C and B by 5 °C. Which object has more specific heat? And by what factor?

**Answer : A,  $\frac{5}{3}$**

- Liquid ammonia is used in ice factory for making ice from water. If water at 20 °C is to be converted into 2 kg ice at 0 °C, how many grams of ammonia are to be evaporated? (Given: The latent heat of vaporization of ammonia= 341 cal/g)

**Answer : 586.4 g**

- A thermally insulated pot has 150 g ice at temperature 0 °C. How much steam of 100 °C has to be mixed to it, so that water of temperature 50 °C will be obtained?

(Given : latent heat of melting of ice = 80 cal/g,  
latent heat of vaporization of water = 540 cal/g,  
specific heat of water = 1 cal/g °C)

**Answer : 33 g**

- A calorimeter has mass 100 g and specific heat 0.1 kcal/ kg °C. It contains 250 gm of liquid at 30 °C having specific heat of 0.4 kcal/kg °C. If we drop a piece of ice of mass 10 g at 0 °C, What will be the temperature of the mixture?

**Answer : 20.8 °C**

### Project

Take help of your teachers to make a working model of Hope's apparatus and perform the experiment. Verify the results you obtain.



I19HZ1



## 6. Refraction of light



➤ Refraction of light

➤ Laws of refraction

➤ Refractive index

➤ Dispersion of light



**Can you recall?**

1. What is meant by reflection of light?
2. What are the laws of reflection?

We have seen that, generally light travels in a straight line. Because of this, if an opaque object lies in its path, a shadow of the object is formed. We have also seen in previous classes how these shadows change due to the change in relative positions of the source of light and the object. But light can bend under some special circumstances as we will see below

### Refraction of light



**Try this.**

**Material:** Glass, 5 rupee coin, Pencil, metallic vessel etc.

#### Activity 1:

1. Take a transparent glass and fill it with water.
2. Dip some portion of a pencil vertically in water and observe the thickness of the portion of the pencil, in water.
3. Now keep the pencil inclined to water surface and observe its thickness.

In both cases, the portion of the pencil inside water appears to be thicker than the portion above water. In the second case, the pencil appears to be broken near the surface of water. Why does it happen?

In both the above activities the observed effects are created due to the change in the direction of light while coming out of water. **Light changes its direction when going from one transparent medium to another transparent medium. This is called the refraction of light.**

#### Activity 3:

1. Keep a glass slab on a blank paper and draw its outline PQRS as shown in figure 6.1.
2. Draw an inclined straight line on the side of PQ so that it intersects PQ at N. Pierce two pins vertically at two points A and B along the line.
3. Look at the pins A and B from the opposite side of the slab and pierce pins C and D vertically so that the images of A and B are in line with C and D.
4. Now remove the chip and the pins and draw a straight line going through points C and D so that it intersects SR at M.
5. Join points M and N. Observe the incident ray AN and emergent ray MD.

The first refraction occurs when light ray enters the glass from air at N on the side PQ. The second refraction occurs when light enters air through glass at point M on the side SR. For the first refraction the angle of incidence is  $i$  while for the second it is  $i_1$ . The angle of refraction at N is  $r$ .

Note that  $i_1 = r$ . In the second refraction, the angle of refraction is  $e$  which is equal to  $i$ . On both parallel sides PQ and RS of the glass slab, the change in direction of light ray is equal but in opposite directions.

Thus, the light ray MD emerging from the glass slab is parallel to the incident ray AN on the side PQ of the slab. But the emergent ray is somewhat displaced with respect to the incident ray.

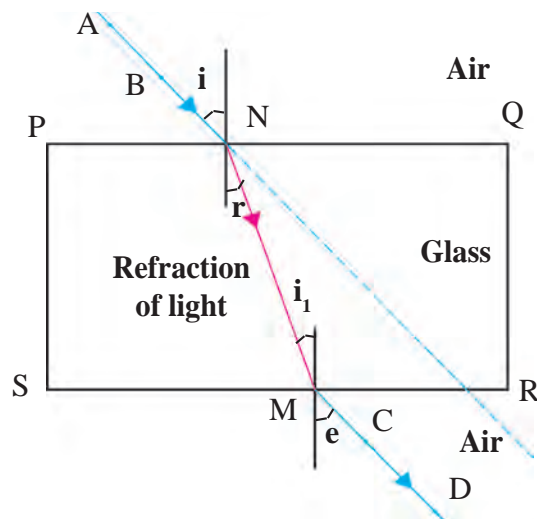

**6.1 Refraction of light passing through a glass slab**



**Use your brain power !**

1. Will light travel through a glass slab with the same velocity as it travels in air?
2. Will the velocity of light be same in all media?

### Laws of refraction

Let us study the light ray entering a glass slab from air as shown in the figure 6.2. Here AN is the incident ray and NB is the refracted ray.

1. Incident ray and refracted ray at the point of incidence N are on the opposite sides of the normal to the surface of the slab at that point i.e. CD, and the three, incident ray, refracted ray and the normal, are in the same plane.
2. For a given pair of media, here air and glass, the ratio of  $\sin i$  to  $\sin r$  is a constant. Here,  $i$  is the angle of incidence and  $r$  is the angle of refraction.

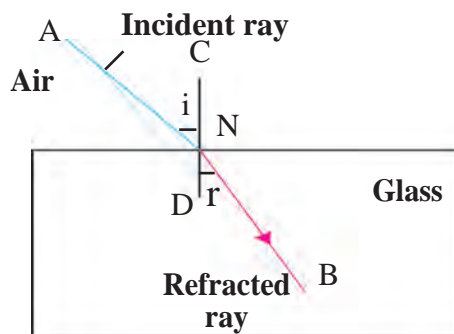

**6.2 Light ray entering a glass slab from air**

### Refractive index

The change in the direction of a light ray while entering different media is different. It is related to the refractive index of the medium. The value of the refractive index is different for different media and also for light of different colours for the same medium. The refractive indices of some substances with respect to vacuum are given in the table. The refractive index of a medium with respect to vacuum is called its absolute refractive index.

**Refractive index depends on the velocity of light in the medium.**

$$\frac{\sin i}{\sin r} = \text{constant} = n$$

$n$  is called the refractive index of the second medium with respect to the first medium. This second law is also called Snell's law. A ray incident along the normal ( $i = 0$ ) goes forward in the same direction ( $r = 0$ ).

Substance	Refractive index	Substance	Refractive index	Substance	Refractive index
Air	1.0003	Fused Quartz	1.46	Carbon disulphide	1.63
Ice	1.31	Turpentine oil	1.47	Dense flint glass	1.66
Water	1.33	Benzene	1.50	Ruby	1.76
Alcohol	1.36	Crown glass	1.52	Sapphire	1.76
Kerosene	1.39	Rock salt	1.54	Diamond	2.42

### Absolute refractive indices of some media

Let the velocity of light in medium 1 be  $v_1$  and in medium 2 be  $v_2$  as shown in figure 6.3. The refractive index of the second medium with respect to the first medium,  ${}^1n_2$  is equal to the ratio of the velocity of light in medium 1 to that in medium 2.

$$\text{Refractive index } {}^1n_2 = \frac{\text{Velocity of light in medium 1 } (v_1)}{\text{Velocity of light in medium 2 } (v_2)}$$

Similarly, the refractive index of medium 1 with respect to medium 2 is

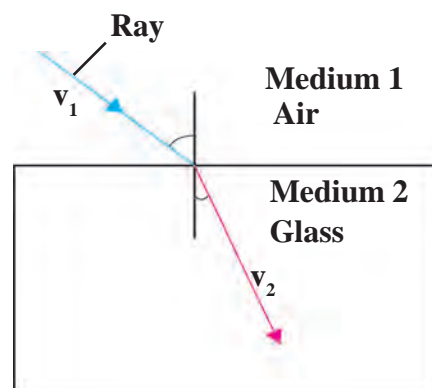

6.3 Light ray going from medium 1 to medium 2

$${}^2n_1 = \frac{v_2}{v_1}$$

If the first medium is vacuum then the refractive index of medium 2 is called absolute refractive index and it is written as  $n$ .



Can you tell?

If the refractive index of second medium with respect to first medium is  ${}^1n_2$  and that of third medium with respect to second medium is  ${}^2n_3$ , what and how much is  ${}^1n_3$ ?

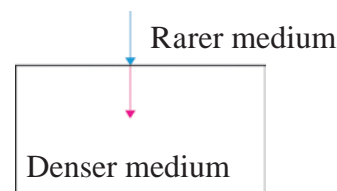
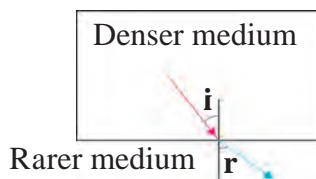
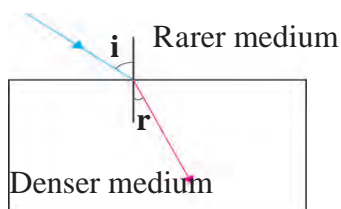

### 6.4 Refraction of light in different media

When a light ray passes from a rarer medium to a denser medium, it bends towards the normal.

When a light ray passes from a denser medium to a rarer medium, it bends away from the normal.

When a light ray is incident normally at the boundary between two media, it does not change its direction and hence does not get refracted.

## Twinkling of stars



Can you tell?

1. Have you seen a mirage which is an illusion of the appearance of water on a hot road or in a desert?
2. Have you seen that objects beyond and above a holi fire appear to be shaking? Why does this happen?

Local atmospheric conditions affect the refraction of light to some extent. In both the examples above, the air near the hot road or desert surface and near the holi flames is hot and hence rarer than the air above it. The refractive index of air keeps increasing as we go to increasing heights. In the first case above, the direction of light rays, coming from a distance, keeps changing according to the laws of refraction.

The light rays coming from a distant object appear to be coming from the image of the object inside the ground as shown in figure 6.5. This is called a mirage.

In the second example, the direction of light rays coming from objects beyond the holi fire changes due to changing refractive index above the fire. Thus, the objects appear to be moving.

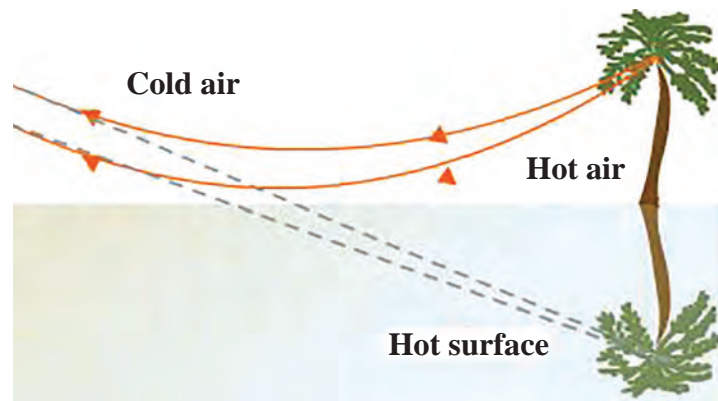

6.5 Mirage

Effect of atmospheric conditions on refraction of light can be seen in the twinkling of the stars.

Stars are self-luminous and can be seen at night in the absence of sunlight. They appear to be point sources because of their being at a very large distance from us. As the density of air increases with lowering height above the surface of the earth, the refractive index also increases. Star light coming towards us travels from rarer medium to denser medium and constantly bends towards the normal. This makes the star appear to be higher in the sky as compared to its actual position as shown in the figure, 6.6.

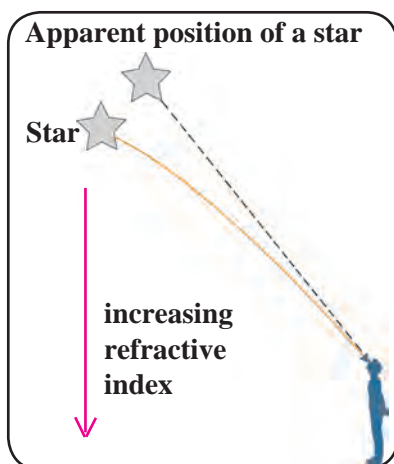

6.6 Apparent position of a star

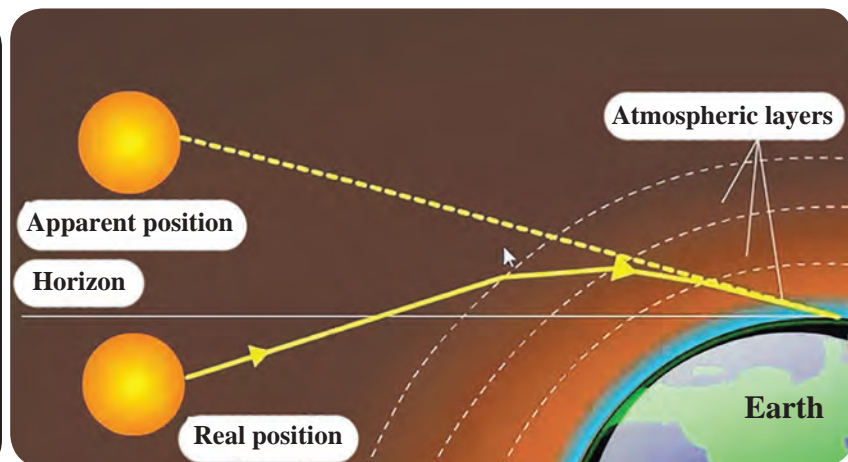

6.7 Effect of atmospheric refraction

The apparent position of the star keeps changing a bit. This is because of the motion of atmospheric air and changing air density and temperature. Because of this, the refractive index of air keeps changing continuously. Because of this change, the position and brightness of the star keep changing continuously and the star appears to be twinkling.



We do not see twinkling of planets. This is because, planets are much closer to us as compared to stars. They, therefore, do not appear as point sources but appear as a collection of point sources. Because of changes in atmospheric refractive index the position as well as the brightness of individual point source change but the average position and total average brightness remains unchanged and planets do not twinkle.

By Sunrise we mean the appearance of the Sun above the horizon. But when the Sun is somewhat below the horizon, its light rays are able to reach us along a curved path due to their refraction through earth's atmosphere as shown in the figure 6.7. Thus, we see the Sun even before it emerges above the horizon. Same thing happens at the time of Sunset and we keep seeing the Sun for a short while even after it goes below the horizon.

## Dispersion of light

Hold the plastic scale in your compass in front of your eyes and see through it while turning it slowly. You will see light rays divided into different colours. These colours appear in the following order: violet, indigo, blue, green, yellow, orange and red. You know that light is electromagnetic radiation. Wavelength is an important property of radiation. The wavelength of radiation to which our eyes are sensitive is between 400 and 700 nm. In this interval, radiation of different wavelengths appears to have different colours mentioned above. The red light has maximum wavelength i.e. close to 700 nm while violet light has the smallest wavelength, close to 400 nm. Remember that  $1 \text{ nm} = 10^{-9} \text{ m}$ .

In vacuum, the velocity of light rays of all frequencies is the same. But the velocity of light in a medium depends on the frequency of light and thus different colours travel with different velocity. Therefore, the refractive index of a medium is different for different colours. Thus, even when white light enters a single medium like glass, the angles of refraction are different for different colours. So when the white light coming from the Sun through air, enters any refracting medium, it emerges as a spectrum of seven colours.

**The process of separation of light into its component colours while passing through a medium is called the dispersion of light.**

Sir Isaac Newton was the first person to use a glass prism to obtain Sun's spectrum. When white light is incident on the prism, different colours bend through different angles. Among the seven colours, red bends the least while violet bends the most. Thus, as shown in figure 6.8, the seven colours emerge along different paths and get separated and we get a spectrum of seven colours.

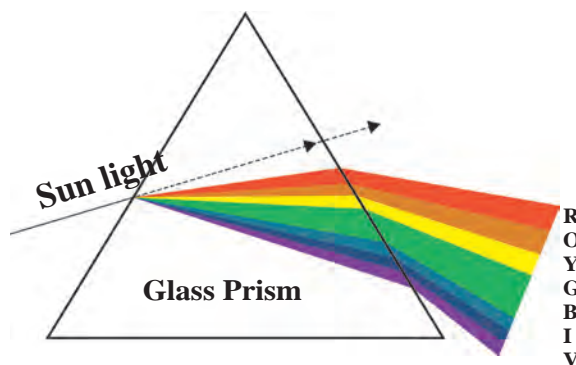

**6.8 Dispersion of light**



**Use your brain power !**

1. From incident white light how will you obtain white emergent light by making use of two prisms?
2. You must have seen chandeliers having glass prisms. The light from a tungsten bulb gets dispersed while passing through these prisms and we see coloured spectrum. If we use an LED light instead of a tungsten bulb, will we be able to see the same effect?

## Partial and total internal reflection

When light enters a rarer medium from a denser medium, it gets partially reflected i.e. part of the light gets reflected and comes back into the denser medium as per laws of reflection. This is called partial reflection. The rest of the light gets refracted and goes into the rarer medium.

As light is going from denser to rarer medium, it bends away from the normal i.e. the angle of incidence  $i$ , is smaller than the angle of refraction  $r$ . This is shown on the left side of the figure 6.9. If we increase  $i$ ,  $r$  will also increase according to Snell's law as the refractive index is a constant.

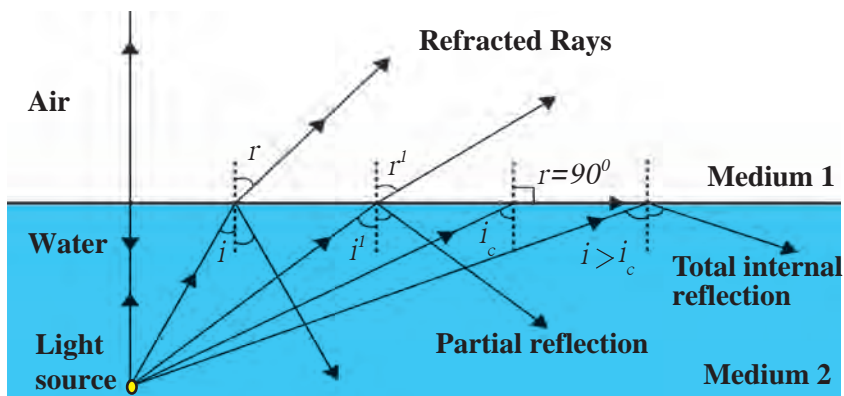

6.9 Partial and total internal reflection

For a particular value of  $i$ , the value of  $r$  becomes equal to  $90^\circ$ . This value of  $i$  is called the critical angle. For angles of incidence larger than the critical angle, the angle of refraction is larger than  $90^\circ$ . Such rays return to the denser medium as shown towards the right in figure 6.9. Thus, all the light gets reflected back into the dense medium. This is called total internal reflection. We can determine the value of the critical angle as follows.

$${}_1n_2 = \frac{\sin i}{\sin r} \quad \text{For total internal reflection, } i = \text{critical angle, } r = 90^\circ$$

$${}_1n_2 = \frac{\sin i}{\sin 90^\circ} = \sin i \quad (\because \sin 90^\circ = 1)$$

Rainbow is a beautiful natural phenomenon. It is the combined effect of a number of natural processes. It is the combined effect of dispersion, refraction and total internal reflection of light. It can be seen mainly after a rainfall. Small droplets of water act as small prisms. When light rays from the Sun enter these droplets, it gets refracted and dispersed. Then there is internal reflection as shown in the figure, and after that once again the light gets refracted while coming out of the droplet. All these three processes together produce the rainbow.

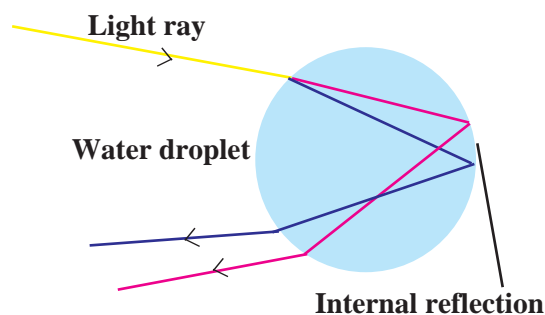

6.10 Rainbow production

### Books are my friends

1. Why the Sky is Blue - Dr. C.V. Raman talks about science : C. V. Raman and Chandralekha
2. Optics : Principles and Applications : K.K. Sharma
3. Theoretical concepts in Physics : M.S. Longair

### Some Fun

Try to see if you can see dispersion of light using plastic jar, mirror and water.

## Solved Examples

1. The absolute refractive index of water is 1.36. What is the velocity of light in water? (velocity of light in vacuum  $3 \times 10^8$  m/s)

**Given:**

$$V_1 = 3 \times 10^8 \text{ m/s}$$

$$n = 1.36$$

$$n = \frac{V_1}{V_2} \quad 1.36 = \frac{3 \times 10^8}{V_2}$$

$$V_2 = \frac{3 \times 10^8}{1.36} = 2.21 \times 10^8 \text{ m/s}$$

2. Light travels with a velocity  $1.5 \times 10^8$  m/s in a medium. On entering second medium its velocity becomes  $0.75 \times 10^8$  m/s. What is the refractive index of the second medium with respect to the first medium?

**Given:**

$$V_1 = 1.5 \times 10^8 \text{ m/s}, V_2 = 0.75 \times 10^8 \text{ m/s}$$

$${}_2n_1 = ? \quad {}_2n_1 = \frac{1.5 \times 10^8}{0.75 \times 10^8} = 2$$

## Exercise

1. Fill in the blanks and Explain the completed sentences.

- a. Refractive index depends on the ..... of light.
- b. The change in ..... of light rays while going from one medium to another is called refraction.

2. Prove the following statements.

- a. If the angle of incidence and angle of emergence of a light ray falling on a glass slab are  $i$  and  $e$  respectively, prove that,  $i = e$ .
- b. A rainbow is the combined effect of the refraction, dispersion, and total internal reflection of light.

3. Mark the correct answer in the following questions.

- A. What is the reason for the twinkling of stars?
  - i. Explosions occurring in stars from time to time
  - ii. Absorption of light in the earth's atmosphere
  - iii. Motion of stars
  - iv. Changing refractive index of the atmospheric gases
- B. We can see the Sun even when it is little below the horizon because of
  - i. Reflection of light
  - ii. Refraction of light
  - iii. Dispersion of light
  - iv. Absorption of light

C. If the refractive index of glass with respect to air is  $3/2$ , what is the refractive index of air with respect to glass?

- |                  |                  |
|------------------|------------------|
| a. $\frac{1}{2}$ | b. 3             |
| c. $\frac{1}{3}$ | d. $\frac{2}{3}$ |

4. Solve the following examples.

a. If the speed of light in a medium is  $1.5 \times 10^8$  m/s, what is the absolute refractive index of the medium?

**Ans : 2**

b. If the absolute refractive indices of glass and water are  $3/2$  and  $4/3$  respectively, what is the refractive index of glass with respect to water?

**Ans :  $\frac{9}{8}$**

### Project :

Using a laser and soap water, study the refraction of light under the guidance of your teacher.



## 7. Lenses



- Lenses
- Sign convention
- Defects of vision and their correction
- Uses of lenses
- Ray diagram for refracted light
- Working of human eye and lens



### Can you recall?

1. Indicate the following terms related to spherical mirrors in figure 7.1: poles, centre of curvature, radius of curvature, principal focus.
2. How are concave and convex mirrors constructed?

### Lenses

You must have seen lenses used in day to day life. Some examples are: the lenses used by old persons for reading, lens embedded in the front door of the house, the lens which the watch maker attaches to his eye etc.

Lenses are used in spectacles. They are also used in telescopes as you have learnt in the previous standard.

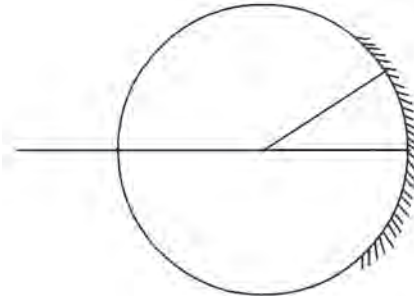

**7.1 Spherical mirror**

A lens is a transparent medium bound by two surfaces. The lens which has two spherical surfaces which are puffed up outwards is called a convex or double convex lens. This lens is thicker near the centre as compared to the edges. The lens with both surfaces spherical on the inside is called a concave or double concave lens. This lens is thinner at the centre as compared to its edges.

Different types of lenses are shown in figure 7.2. A ray of light gets refracted twice while passing through a lens, once while entering the lens and once while emerging from the lens. The direction of the ray changes because of these refractions. Both the surfaces of most lenses are parts of a sphere.

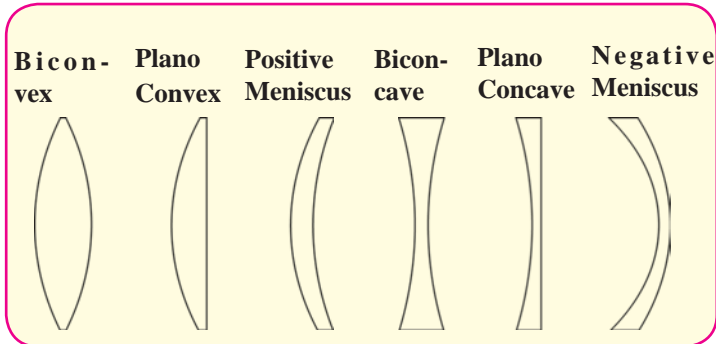

**7.2 Types of lenses**

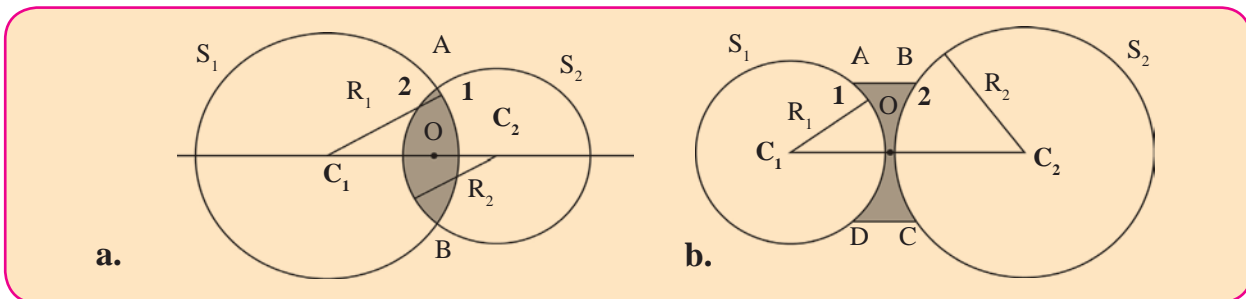

**7.3 Cross-sections of convex and concave lenses.**

The cross-sections of convex and concave lenses are shown in parts a and b of figure 7.3. The surface marked as 1 is part of sphere  $S_1$  while surface 2 is part of sphere  $S_2$ .



**Centre of curvature (C) :** The centres of spheres whose parts form surfaces of the lenses are called centres of curvatures of the lenses. A lens with both surfaces spherical, has two centres of curvature  $C_1$  and  $C_2$ .

**Radius of curvature (R) :** The radii ( $R_1$  and  $R_2$ ) of the spheres whose parts form surfaces of the lenses are called the radii of curvature of the lens.

**Principal axis :** The imaginary line passing through both centres of curvature is called the principal axis of the lens.

**Optical centre (O) :** The point inside a lens on the principal axis, through which light rays pass without changing their path is called the optical centre of a lens. In figure 7.4, rays  $P_1Q_1$ ,  $P_2Q_2$  passing through O are going along a straight line. Thus O is the optical centre of the lens.

**Principal focus (F) :** When light rays parallel to the principal axis are incident on a convex lens, they converge to a point on the principal axis. This point is called the principal focus of the lens. As shown in figure 7.5a  $F_1$  and  $F_2$  are the principal foci of the convex lens.

Light rays parallel to the principal axis falling on a convex lens come together i.e. get focused at a point on the principal axis. So this type of lens is called a converging lens.

Rays travelling parallel to the principal axis of a concave lens diverge after refraction in such a way that they appear to be coming out of a point on the principal axis. This point is called the principal focus of the concave lens. As shown in figure 7.5b  $F_1$  and  $F_2$  are the principal foci of the concave lens.

Light rays parallel to the principal axis falling on a concave lens go away from one another (diverge) after refraction. So this type of lens is called a divergent lens.

**Focal length (f) :** The distance between the optical centre and principal focus of a lens is called its focal length.

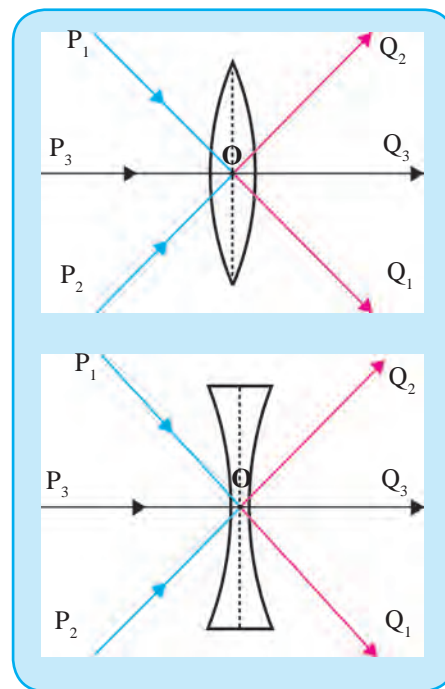

7.4 Optical centre of a lens

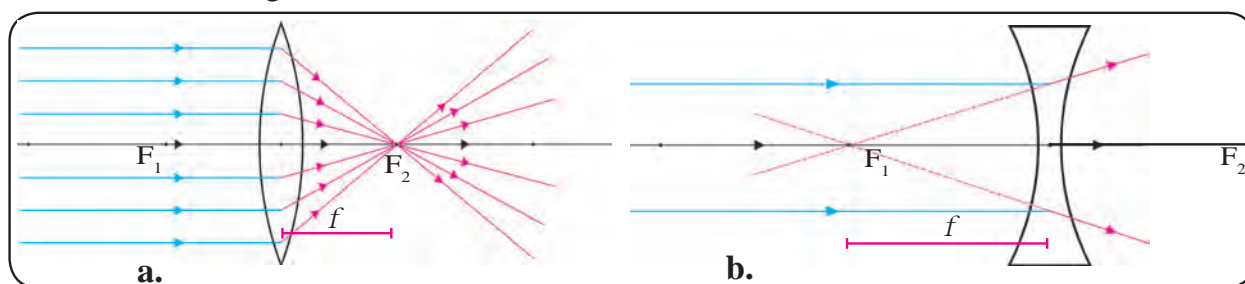

7.5 Principal focus of a lens



**Try this.**

**Material:** Convex lens, screen, meter scale, stand for the lens etc.

**Method:**

Keeping the screen fixed, obtain a clear image of a distant object like a tree or a building with the help of the lens on the screen. Measure the distance between the screen and the lens with the help of the meter scale. Now turn the other side of the lens towards the screen. Again obtain a clear image of the distant object on the screen by moving the lens forward or backward. Measure the distance between the screen and the lens again.

What is this distance between the lens and the screen called? Discuss the relation between this distance and the radius of curvature of the lens with your teacher. The image of a distant object is obtained close to the focus of the lens, hence, the above distance is the focal length of the lens. What will happen if you use a concave lens in this experiment?

**Ray diagram for refraction :** You have learnt the rules for drawing ray diagrams for spherical mirrors. Similarly, one can obtain the images formed by lenses with the help of ray diagrams. One can obtain the position, size and nature of the images with the help of these diagrams.

### Images formed by convex lenses

One can use following three rules to draw ray diagrams of images obtained by convex lenses.

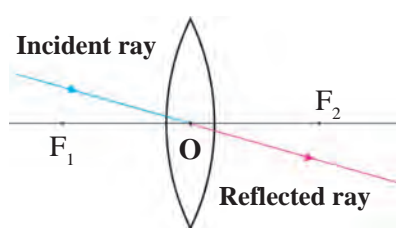
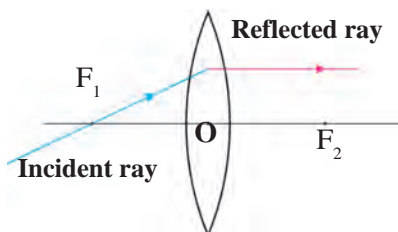
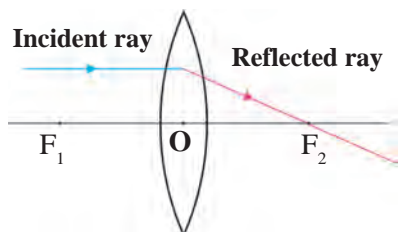

**Rule 1:** When the incident ray is parallel to the principal axis, the refracted ray passes through the principal focus.

**Rule 2:** When the incident ray passes through the principal focus, the refracted ray is parallel to the principal axis.

**Rule 3:** When the incident ray passes through the optical centre of the lens, it passes without changing its direction.



### Try This

**Material:** A convex lens, screen, meter scale, stand for the lens, chalk, candle etc.

### Method:

1. Draw a straight line along the centre of a long table.
2. Place the lens on the stand at the central point (O) of the line.
3. Place the screen on one side, of the lens. Move it along the line so as to get a clear image of a distant object. Mark its position as  $F_1$ .
4. Measure the distance between O and  $F_1$ . Mark a point at distance  $2F_1$  from O on the same side of  $F_1$  and mark it as  $2F_1$ .
5. Repeat actions 3 and 4 on the other side of the lens and mark  $F_2$  and  $2F_2$  on the straight line.
6. Now place the burning candle on the other side of lens far beyond  $2F_1$ . Place the screen on the opposite side of the lens and obtain a clear image of the candle by moving it forward or backward along the line. Note the position, size and nature of the image.
7. Repeat action 6 by placing the candle beyond  $2F_1$ , at  $2F_1$ , between  $2F_1$  and  $F_1$ , at  $F_1$  and between  $F_1$  and O. Note your observations.

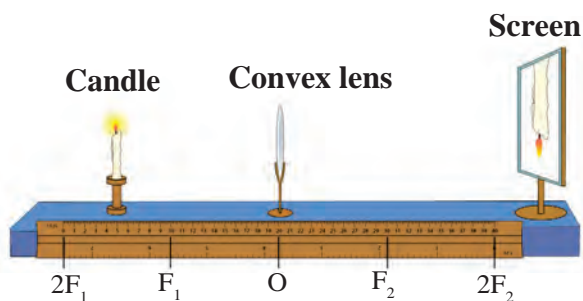

### 7.6 Arrangement for the experiment



### Can you recall?

What are real and virtual images? How will you find out whether an image is real or virtual? Can a virtual image be obtained on a screen?

As shown in the figure 7.7, an object AB is placed beyond the point  $2F_1$ . The incident ray BC, starting from B and going parallel to the principal axis, goes through the principal focus  $F_2$  after refraction along CT. The ray BO, starting from B and passing through the optical centre O of the lens goes along OS without changing its direction. It intersects CT in  $B'$ . This means that the image of B is formed at  $B'$ .

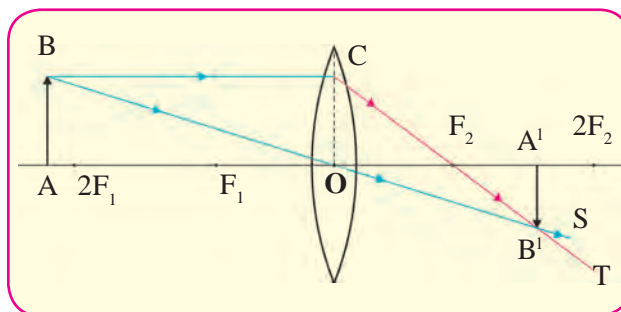

**7.7 Real image formed by a convex lens**

As A is situated on the principal axis, its image will also be located along the principal axis at  $A'$ , vertically above  $B'$ . Thus,  $A'B'$  will be the image of AB formed by the lens. So we learn that if an object is placed beyond  $2F_1$ , the image is formed between  $F_2$  and  $2F_2$ . It is real and inverted and its size is smaller than that of the object.



### Observe

Study figure 7.8. Determine the position, size and nature of images formed for different positions of an object with the help of ray diagrams. Check your conclusions and observations in the previous activity with those given in the table.

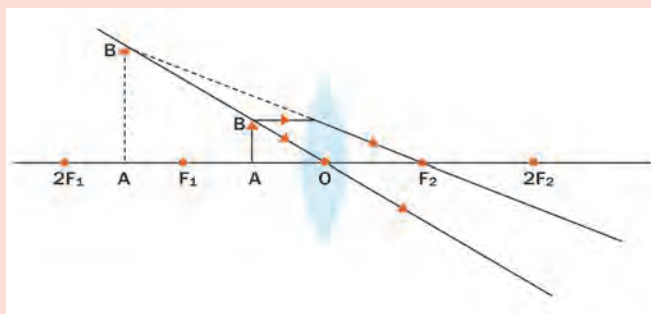

**7.8 Images formed by position of an object**

### Images formed by convex lenses for different positions of the object.

S. No.	Position of the object	Position of the image	Size of the image	Nature of the image
1	At infinity	At focus $F_2$	Point image	Real and inverted
2	Beyond $2F_1$	Between $F_2$ and $2F_2$	Smaller	Real and inverted
3	At $2F_1$	At $2F_2$	Same size	Real and inverted
4	Between $F_1$ and $2F_1$	Beyond $2F_2$	Larger	Real and inverted
5	At focus $F_1$	At infinity	Very large	Real and inverted
6	Between $F_1$ and O	On the same side of the lens as the object	Very large	Virtual and erect

### Images formed by concave lenses

We can obtain the images obtained by concave lenses using the following rules.

1. When the incident ray is parallel to the principal axis, the refracted ray when extended backwards, passes through the focus.
2. When the incident ray passes through the focus, the refracted ray is parallel to the principal axis.

As shown in figure 7.9, object PQ is placed between  $F_1$  and  $2F_1$  in front of a concave lens. The incident ray PA, starting from P and going parallel to the principal axis goes along AD after refraction. If AD is extended backwards, it appears to come from  $F_1$ . The incident ray PO, starting from P and passing through O, goes along the same direction after refraction. PO intersects the extended ray  $AF_1$  at  $P^1$ , i.e.  $P^1$  is the image of P.

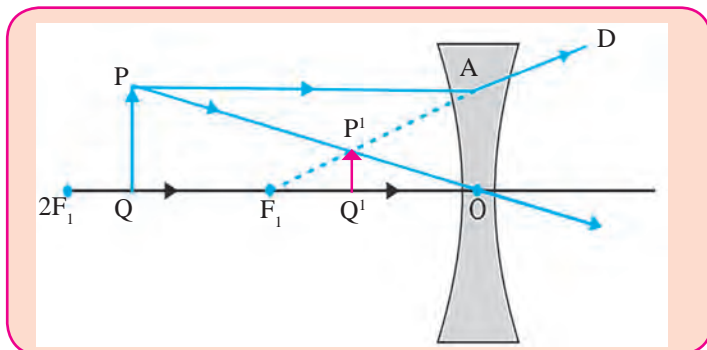

7.9 Image formed by a concave lens

As the point Q is on the principal axis, its image is formed along the axis at the point  $Q^1$  directly below  $P^1$ . Thus,  $P^1Q^1$  is the image of PQ. The image formed by a concave lens is always virtual, erect and smaller than the object.

Sr. No.	Position of the object	Position of the image	Size of the image	Nature of the image
1	At infinity	On the first focus $F_1$	Point image	Virtual and erect
2	Anywhere between optical centre O and infinity	Between optical centre and focus $F_1$	Small	Virtual and erect



Can you recall?

What is the Cartesian sign convention used for spherical mirrors?

### Sign convention

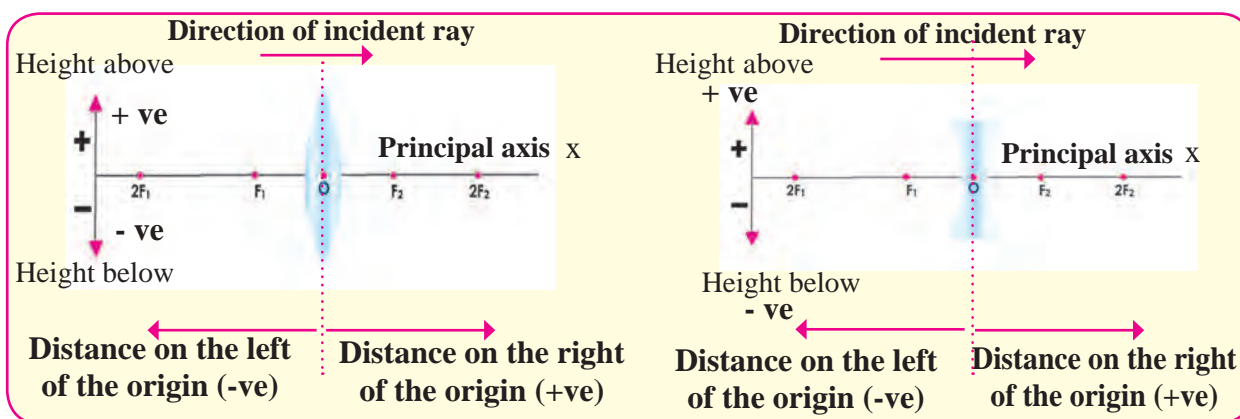

7.10 Cartesian sign convention

### Lens formula

The formula showing the relation between distance of the object ( $u$ ), the distance of the image ( $v$ ) and the focal length ( $f$ ) is called the lens formula. It is given below.

$$\frac{1}{v} - \frac{1}{u} = \frac{1}{f}$$

The lens formula is same for any spherical lens and any distance of the object from the lens. It is however necessary to use the sign convention properly.



According to the Cartesian sign convention, the optical centre (O) is taken to be the origin. The principle axis is the X-axis of the frame of reference. The sign convention is as follows.

1. The object is always placed on the left of the lens, All distances parallel to the principal axis are measured from the optical centre (O).
2. The distanced measured to the right of O are taken to be positive while those measured to the left are taken to be negative.
3. Distances perpendicular to the principal axis and above it are taken to be positive.
4. Distances perpendicular to the principal axis and below it are taken to be negative.
5. The focal length of a convex lens is positive while that of a concave lens is negative.

### Magnification (M)

The magnification due to a lens is the ratio of the height of the image ( $h_2$ ) to the height of the object ( $h_1$ ).

$$\text{Magnification} = \frac{\text{Height of the Image}}{\text{Height of the object}} \quad \text{i.e. } M = \frac{h_2}{h_1} \quad \dots\dots\dots (1)$$

The magnification due to a lens is also related to the distance of the object ( $u$ ) and that of the image ( $v$ ) from the lens.

$$\text{Magnification} = \frac{\text{Distance of the Image}}{\text{Distance of the object}} \quad \text{i.e. } M = \frac{v}{u} \quad \dots\dots\dots (2)$$



### Use your brain power !

From equations (1) and (2) what is the relation between  $h_1$ ,  $h_2$ ,  $u$  and  $v$ ?

Take two convex lenses of different sizes. Collect sunlight on a paper using one of the lenses. The paper will start burning after a while. Note the time required for the paper to start burning. Repeat the process for the second lens. Is the time required the same in both cases? What can you tell from this ?

### Power of a lens

The capacity of a lens to converge or diverge incident rays is called its power (P). The power of a lens depends on its focal length. Power is the inverse of its focal length (f); f is expressed in meters.

The unit of the power of a lens is Diopetre (D).

$$P = \frac{1}{f \text{ (m)}} \qquad 1 \text{ Diopetre} = \frac{1}{1 \text{ m}}$$

### Combination of lenses

If two lenses with focal lengths  $f_1$  and  $f_2$  are kept in contact with each other, the combination has an effective focal length given by

$$\frac{1}{f} = \frac{1}{f_1} + \frac{1}{f_2}$$

If the powers of the two lenses are  $P_1$  and  $P_2$  then the effective power of their combination is  $P = P_1 + P_2$ . Thus, when two lenses are kept touching each other, the power of the combined lens is equal to the sum of their individual powers.

### Solved Examples

1. An object is placed vertically at a distance of 20 cm from a convex lens. If the height of the object is 5 cm and the focal length of the lens is 10 cm, what will be the position, size and nature of the image? How much bigger will the image be as compared to the object?

**Given:**

Height of the object ( $h_1$ ) = 5 cm,  
 focal length ( $f$ ) = 10 cm,  
 distance of the object ( $u$ ) = - 20 cm  
 Image distance ( $v$ ) = ?,  
 Height of the image ( $h_2$ ) = ?,  
 Magnification ( $M$ ) = ?

$$\frac{1}{v} - \frac{1}{u} = \frac{1}{f}$$

$$\frac{1}{v} = \frac{1}{u} + \frac{1}{f}$$

$$\frac{1}{v} = \frac{1}{-20} + \frac{1}{10}$$

$$\frac{1}{v} = \frac{-1 + 2}{20}$$

$$\frac{1}{v} = \frac{1}{20},$$

$$v = 20 \text{ cm}$$

The positive sign of the image distance shows that image is formed at 20 cm on the other side of the lens.

$$\text{Magnification (M)} = \frac{h_2}{h_1} = \frac{v}{u}$$

$$h_2 = \frac{v}{u} \times h_1$$

$$h_2 = \frac{20}{-20} \times 5$$

$$h_2 = (-1) \times 5$$

$$h_2 = -5 \text{ cm}$$

$$M = \frac{v}{u} = \frac{20}{-20} = -1$$

The negative sign of the height of the image and the magnification shows that the image is inverted and real. It is below the principal axis and is of the same size as the object.

2. The focal length of a convex lens is 20 cm. What is its power?

Given: Focal length =  $f = 20 \text{ cm} = 0.2 \text{ m}$

Power of the lens =  $P = ?$

$$P = \frac{1}{f \text{ (m)}} = \frac{1}{0.2} = 5 \text{ D}$$

The power of the lens is 5 D.



### Observe and Discuss

Study the model depicting the construction of human eye with the help of teachers.

### Human eye and working of its lens

There is a very thin transparent cover ( membrane) on the human eye. This is called cornea (fig 7.11). Light enters the eye through it. Maximum amount of incident light is refracted inside the eye at the outer surface of the cornea. There is a dark, fleshy screen behind the cornea. This is called the Iris. The colour of the Iris is different for different people. There is a small hole of changing diameter at the centre of the Iris which is called the pupil. The pupil controls the amount of light entering the eye. If the light falling on the eye is too bright, pupil contracts while if the light is dim, it widens. On the surface of the iris, there is bulge of transparent layers. There is a double convex transparent crystalline lens, just behind the pupil. The lens provides small adjustments of the focal length to focus the image. This lens creates real and inverted image of an object on the screen inside the eye.

This screen is made of light sensitive cells and is called the retina. These cells get excited when light falls on them and generate electric signals. These signals are conveyed to the brain through optic nerve. Later, the brain analyses these signals and converts them in such a way that we perceive the objects as they actually are.

While seeing objects at large, infinite distances, the lens of the eye becomes flat and its focal length increases as shown in part a of the figure 7.12. While seeing nearby objects the lens becomes more rounded and its focal length decreases as shown in part b of the figure 7.12. This way we can see objects clearly irrespective of their distance.

The capacity of the lens to change its focal length as per need is called its power of accommodation. Although the elastic lens can change its focal length, to increase or decrease it, it can not do so beyond a limit.

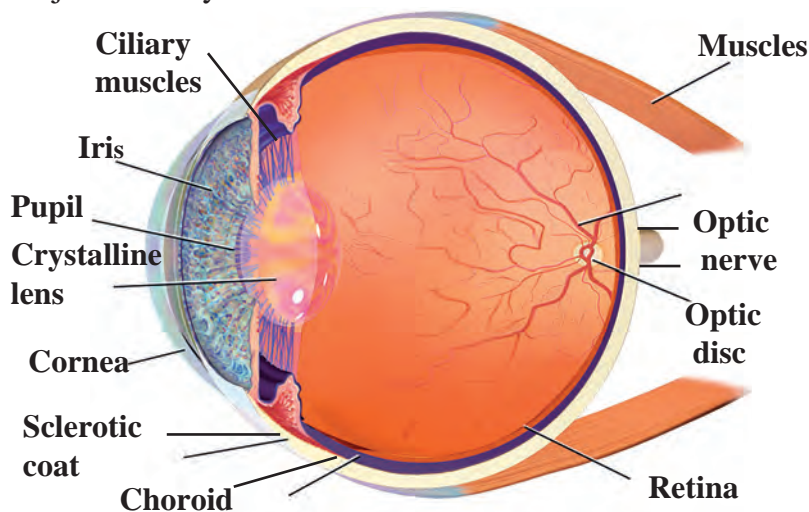
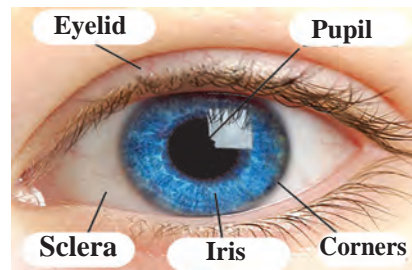

**7.11 Construction of human eye**

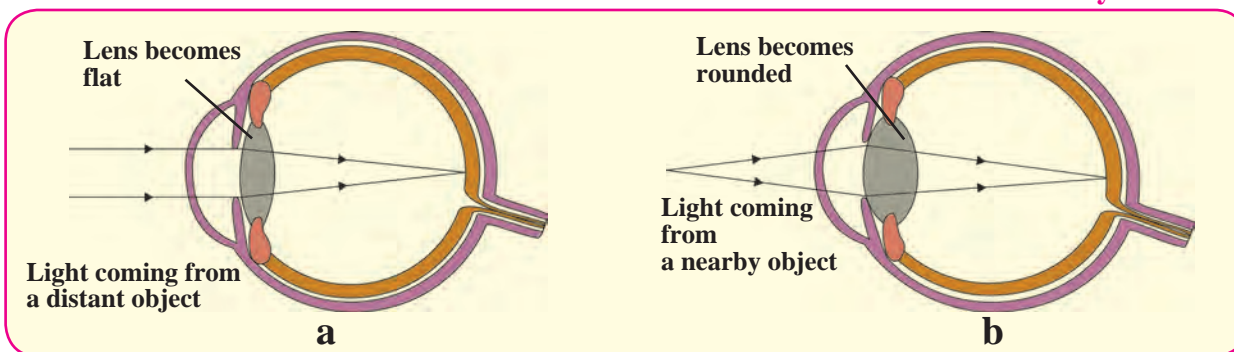

**7.12 The change in the shape of the lens while seeing distant and nearby objects.**

The minimum distance of an object from a normal eye, at which it is clearly visible without stress on the eye, is called as minimum distance of distinct vision. The position of the object at this distance is called the near point of the eye, for a normal human eye, the near point is at 25 cm. The farthest distance of an object from a human eye, at which it is clearly visible without stress on the eye is called farthest distance of distinct vision. The position of the object at this distance is called the far point of the eye. For a normal human eye, the far point is at infinity.



**Do you know ?**

The eye ball is approximately spherical and has a diameter of about 2.4 cm. The working of the lens in human eye is extremely important. The lens can change its focal length to adjust and see objects at different distances. In a relaxed state, the focal length of healthy eyes is 2 cm. The other focus of the eye is on the retina.



1. Try to read a book keeping it very far from your eyes.
2. Try to read a book keeping it very close to your eyes.
3. Try to read a book keeping it at a distance of 25 cm from your eyes. At which time you see the alphabets clearly? Why?

## Defects of Vision and their corrections

Some people can not see things clearly due to loss of accommodation power of the lenses in their eyes. Because of defective refraction by the lenses their vision becomes faint and fuzzy. In general, there are three types of refraction defects.

### 1. Nearsightedness/ Myopia

In this case, the eye can see nearby objects clearly but the distant objects appear indistinct.

This means that the far point of the eye is not at infinity but shifts closer to the eye. In nearsightedness, the image of a distant object forms in front of the retina (see figure 7.13). There are two reasons for this defect.

1. The curvature of the cornea and the eye lens increases. The muscles near the lens can not relax so that the converging power of the lens remains large.
2. The eyeball elongates so that the distance between the lens and the retina increases.

This defect can be corrected by using spectacles with concave lens of proper focal length. This lens diverges the incident rays and these diverged rays can be converged by the lens in the eye to form the image on the retina. The focal length of concave lens is negative, so a lens with negative power is required for correcting nearsightedness. The power of the lens is different for different eyes depending on the magnitude of their nearsightedness.

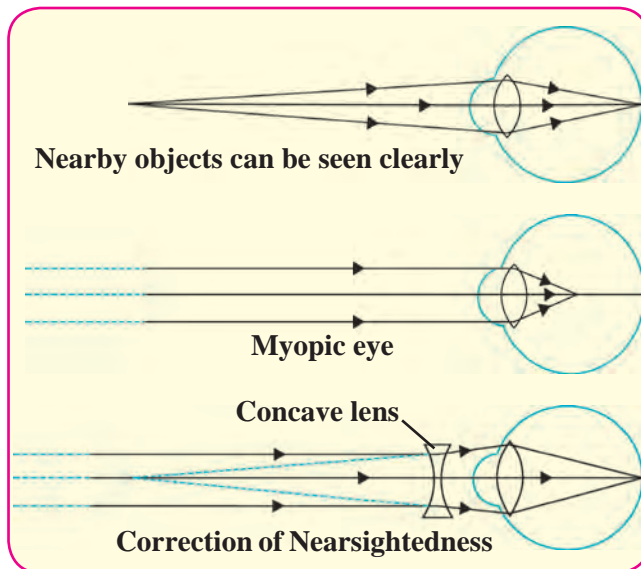

7.13 Nearsightedness

### 2. Farsightedness or hypermetropia

In this defect the human eye can see distant objects clearly but cannot see nearby objects distinctly. This means that the near point of the eye is no longer at 25 cm but shifts farther away. As shown in the figure (7.14), the images of nearby objects get formed behind the retina.

There are two reasons for farsightedness.

1. Curvature of the cornea and the eye lens decreases so that, the converging power of the lens becomes less.
2. Due to the flattening of the eye ball the distance between the lens and retina decreases.

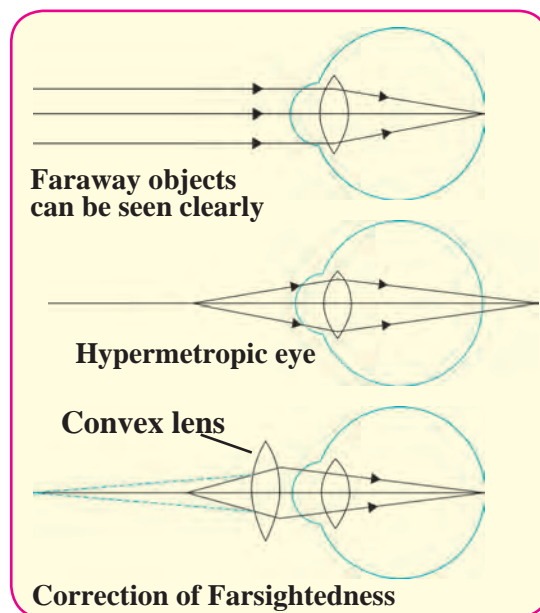

7.14 Farsightedness



This defect can be corrected by using a convex lens with proper focal length. This lens converges the incident rays before they reach the lens. The lens then converges them to form the image on the retina.

The focal length of a convex lens is positive thus the spectacles used to correct farsightedness has positive power. The power of these lenses is different depending on the extent of farsightedness.

### 3. Presbyopia

Generally, the focusing power of the eye lens decreases with age. The muscles near the lens lose their ability to change the focal length of the lens. The near point of the lens shifts farther from the eye. Because of this old people cannot see nearby objects clearly.

Sometimes people suffer from nearsightedness as well as farsightedness. In such a case bifocal lenses are required to correct the defect. In such lenses, the upper part is concave lens and corrects nearsightedness while the lower part is a convex lens which corrects the farsightedness.



#### Try this.

1. Make a list of students in your class using spectacles.
2. Record the power of their lenses.

Find out and note which type of defect of vision they suffer from. Which defect is most common among the students?



#### Internet my friend

Get more information from the following websites.

[www.physics.org](http://www.physics.org)

[www.britannica.com](http://www.britannica.com)

### Apparent size of an object

Consider two objects, PQ and  $P_1Q_1$ , having same size but kept at different distances from an eye as shown in figure 7.15. As the angle  $\alpha$  subtended by PQ at the eye is larger than the angle  $\beta$  subtended by  $P_1Q_1$ , PQ appears bigger than  $P_1Q_1$ . Thus, the apparent size of an object depends on the angle subtended by the object at the eye.

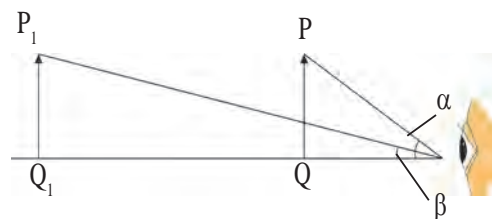

7.15 Apparent Size of An object.



#### Use your brain power !

1. Why do we have to bring a small object near the eyes in order to see it clearly?
2. If we bring an object closer than 25 cm from the eyes, why can we not see it clearly even though it subtends a bigger angle at the eye?

### Use of concave lenses

- a. Medical equipments, scanner, CD player – These instruments use laser light. For proper working of these equipments concave lenses are used.
- b. The peep hole in door- This is a small safety device which helps us see a large area outside the door. This uses one or more concave lenses.
- c. Spectacles- Concave lenses are used in spectacles to correct nearsightedness.
- d. Torch- Concave lens is used to spread widely the light produced by a small bulb inside a torch.
- e. Camera, telescope and microscope- These instruments mainly use convex lenses. To get good quality images a concave lens is used in front of the eyepiece or inside it.

## Use of convex lenses

**a. Simple microscope :** A convex lens with small focal length produces a virtual, erect and bigger image of an object as shown in the figure. Such a lens is called simple microscope or magnifying lens. One can get a 20 times larger image of an object using such microscopes. These are used for watch repair, testing precious gems and finding their defects.

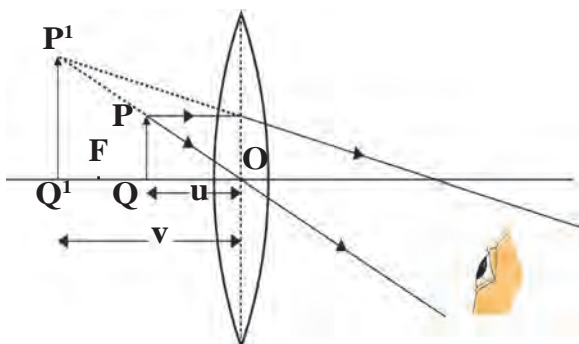

a. Object is close to the lens

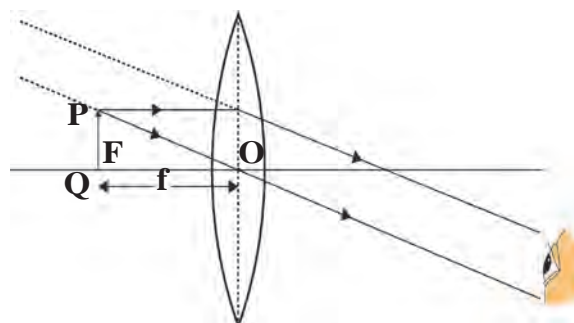

b. Object is at the focus

### 7.16 Simple microscope

## b. Compound microscope

Simple microscope is used to observe small sized objects. But minute objects like blood cells, cells of plants and animals and minute living beings like bacteria cannot be magnified sufficiently by simple microscope. Compound microscopes are used to study these objects. A compound microscope is made of two convex lenses: objective and eye piece. The objective has smaller cross-section and smaller focal length. The eye piece has bigger cross-section, its focal length is also larger than that of the objective. Higher magnification can be obtained by the combined effect of the two lenses.

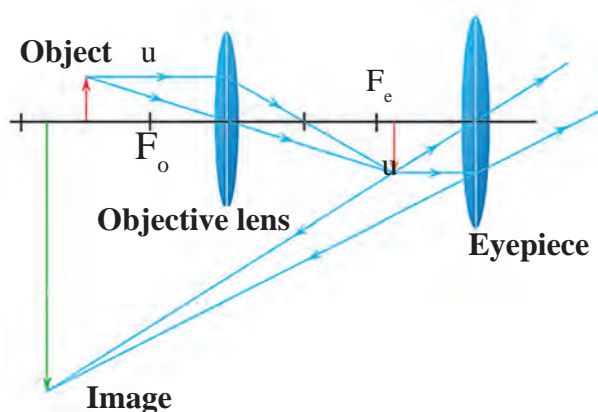

### 7.17 A compound microscope

As shown in the figure 7.17, the magnification occurs in two stages. The image formed by the first lens acts as the object for the second lens. The axes of both lenses are along the same line. The lenses are fitted inside a metallic tube in such a way that the distance between can be changed.

## c. Telescope

Telescope is used to see distant objects clearly in their magnified form. The telescopes used to observe astronomical sources like the stars and the planets are called astronomical telescopes. Telescopes are of two types.

1. Refracting telescope – This uses lenses
2. Reflecting telescope – This uses mirrors and also lenses.

In both of these, the image formed by the objective acts as object for the eye piece which forms the final image. Objective lens has large diameter and larger focal length because of which maximum amount of light coming from the distant object can be collected.

On the other hand the size of the eyepiece is smaller and its focal length is also less. Both the lenses are fitted inside a metallic tube in such a way that the distance between them can be changed. The principal axes of both the lenses are along the same straight line. Generally, using the same objective but different eye pieces, different magnification can be obtained.

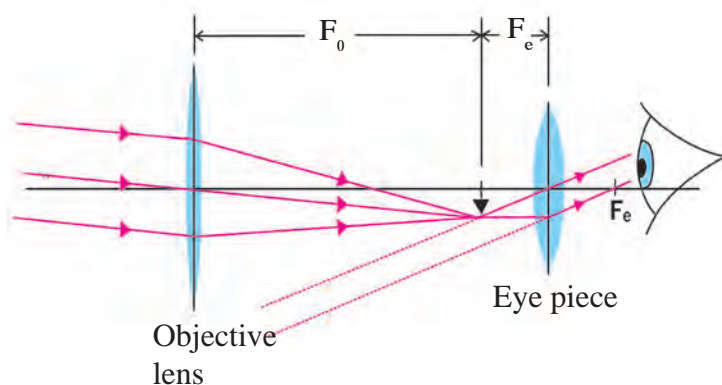

**7.18 Refracting telescope**

#### d. Optical instrument

Convex lenses are used in various other optical instruments like camera, projector, spectrograph etc.



#### Try this.

#### e. Spectacles

Convex lenses are used in spectacles for correcting farsightedness .

1. Take a burning incense stick in your hand and rotate it fast along a circle.
2. Draw a cage on one side of a cardboard and a bird on the other side. Hang the cardboard with the help of a thread. Twist the thread and leave it. What do you see and why?

#### Persistence of vision

We see an object because the eye lens creates its image on the retina. The image is on the retina as long as the object is in front of us. The image disappears as soon as the object is taken away. However, this is not instantaneous and the image remains imprinted on our retina for 1/16th of a second after the object is removed. The sensation on retina persists for a while. This is called persistence of vision. What examples in day to day life can you think about this?



#### Can you tell?

How do we perceive different colours?

The retina in our eyes is made up of many light sensitive cells. These cells are shaped like a rod and like a cone. The rod like cells respond to the intensity of light and give information about the brightness or dimness of the object to the brain. The conical cells respond to the colour and give information about the colour of the object to the brain. Brain processes all the information received and we see the actual image of the object. Rod like cells respond to faint light also but conical cells do not. Thus we perceive colours only in bright light. The conical cells can respond differently to red, green and blue colours. When red colour falls on the eyes, the cells responding to red light get excited more than those responding to other colours and we get the sensation of red colour. Some people lack conical cells responding to certain colours. These persons cannot recognize those colours or cannot distinguish between different colours. These persons are said to be colour blind. Apart from not being able to distinguish between different colours, their eye sight is normal.

## Exercise

1. Match the columns in the following table and explain them.

Column 1	Column 2	Column 3
Farsightedness	Nearby object can be seen clearly	Bifocal lens
Presbyopia	Far away object can be seen clearly	Concave lens
Nearsightedness	Problem of old age	Convex lens

2. Draw a figure explaining various terms related to a lens.

3. At which position will you keep an object in front of a convex lens so as to get a real image of the same size as the object? Draw a figure.

4. Give scientific reasons:

- Simple microscope is used for watch repairs.
- One can sense colours only in bright light.
- We can not clearly see an object kept at a distance less than 25 cm from the eye.

5. Explain the working of an astronomical telescope using refraction of light.

6. Distinguish between:

- Farsightedness and Nearsightedness
- Concave lens and Convex Lens

7. What is the function of iris and the muscles connected to the lens in human eye?

8. Solve the following examples.

- Doctor has prescribed a lens having power +1.5 D. What will be the focal length of the lens? What is the type of the lens and what must be the defect of vision?

(Ans: +0.67m, farsightedness)

- 5 cm high object is placed at a distance of 25 cm from a converging lens of focal length of 10 cm. Determine the position, size and type of the image.

(Ans : 16.7 cm, 3.3 cm, Real)

- Three lenses having power 2, 2.5 and 1.7 D are kept touching in a row. What is the total power of the lens combination?

(Ans : 6.2 D)

- An object kept 60 cm from a lens gives a virtual image 20 cm in front of the lens. What is the focal length of the lens? Is it a converging lens or diverging lens?

(Ans: -30 cm, lens is diverging or concave)

### Project

Make a Power point presentation about the construction and use of binoculars.





## 8. Metallurgy



- Physical properties of metals
- Chemical properties of metals
- Chemical properties of nonmetals
- Metallurgy: Various concepts.
- Physical properties of nonmetals
- Reactivity series of metals
- Ionic compounds.

Earth was born about 4.5 billion years ago. Various formative processes have been taking place in the core of the earth and its surroundings since its creation till today. These have resulted in the formation of various ores, liquids and gases.



### Think about it

Which method do we use when we want to study many things together and at the same time?

The substances around us are in the form of some or the other elements or their compounds. In the beginning, elements were classified in accordance with their chemical and physical properties into the types metals, nonmetals and metalloids, and these are in use even today. You have studied their characteristics in the last standard. We are going to get more information about them in this lesson.



### Can you tell?

What are the physical properties of metals and nonmetals?

### Physical properties of metals

Metals exist mainly in solid state. The metals namely, mercury and gallium exist in liquid state at room temperature. Metals possess luster. The metallic luster goes on decreasing due to exposure to atmospheric oxygen and moisture and also in presence of some reactive gases.

We know that metals have the properties namely, ductility and malleability. Similarly, all metals are good conductors of heat and electricity. Generally, all metals are hard. However, the alkali metals from group 1 such as lithium, sodium and potassium are exceptions. These metals can be cut with knife as they are very soft. Metals have high melting and boiling points. For example, tungsten metal has the highest melting point (3422 °C). On the contrary, the melting and boiling points of the metals such as sodium, potassium, mercury, gallium are very low. A sound is produced when certain metals are struck. This is called sonority. These metals are known as sonorous metals.

### Physical properties of nonmetals

When properties of nonmetals are considered, it is found that some nonmetals are in solid state while some are in gaseous state. Exception is the nonmetal bromine which exists in liquid state. Nonmetals do not possess luster, but iodine is the exception as its crystals are shiny. Nonmetals are not hard. Diamond which as an allotrope of carbon is the exception. Diamond is the hardest natural substance. Nonmetals have low melting and boiling points. Nonmetals are bad conductors of electricity and heat. Graphite, an allotrope of carbon, is an exception, as it is a good conductor of electricity.

## Chemical properties of metals

Metals are reactive. They lose electrons easily and become positively charged ions. That is why metals are called electropositive elements.



**Try this.**

**Apparatus :** Pair of tongs or spatula, knife, burner, etc.

**Chemicals :** Samples of aluminium, copper, iron, lead, magnesium, zinc and sodium.

**(Note:** Use sodium carefully, in presence of teacher)

**Procedure :** Hold the sample of each of the above metals at the top of the flame of a burner with the help of a pair of tongs, or a spatula.

1. Which metal catches fire readily?
2. How does the surface of a metal appear on catching fire?
3. What is the colour of the flame while the metal is burning on the flame?

### Reactions of Metals:

#### a. Reaction of metals with oxygen

Metals combine with oxygen on heating in air and metal oxides are formed. Sodium and potassium are very reactive metals. Sodium metal combines with oxygen in the air even at room temperature and forms sodium oxide.



On exposure to air sodium readily catches fire. Therefore, to prevent accident in the laboratory or elsewhere it is kept in kerosene. Oxides of some metals are soluble in water. They react with water to form alkali.

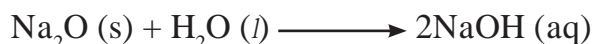

We know that magnesium oxide is formed on burning magnesium ribbon in the air. Magnesium oxide reacts with water to form an alkali, called magnesium hydroxide.

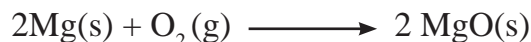

#### b. Reaction of metals with water

**Apparatus :** Beakers.

**Chemicals :** Samples of various metals (Important note : Sodium metal should not be taken), water.

**Procedure :** Drop a piece of each of the metal in separate beakers filled with cold water.

1. Which metal reacts with water?
2. Which metal floats on water? Why? Prepare a table with reference to the above procedure and note your observations in it.



### Do you know ?

Substances which are good conductors of heat are usually good conductors of electricity as well. Similarly bad conductors of heat are also bad conductors of electricity. The exception is diamond which is bad conductor of electricity but good conductor of heat.

#### Metal sample held on a spatula

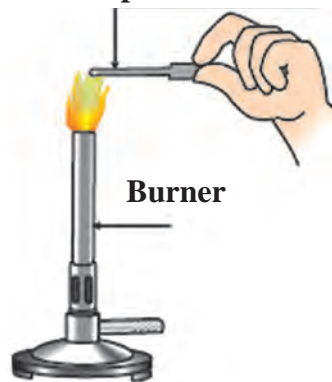

### 8.1 Combustion of metal

Sodium and potassium metal react rapidly and vigorously with water and liberates hydrogen gas.

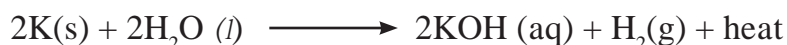

On the other hand, calcium reacts with water slowly and less vigorously. The hydrogen gas released in this reaction collects on the surface of the metal in the form of bubbles and the metal floats on water.

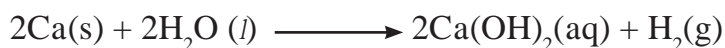

The metals; aluminium, iron and zinc do not react with cold or hot water, but they react with steam to form their oxides. Hydrogen gas is released in this reaction.

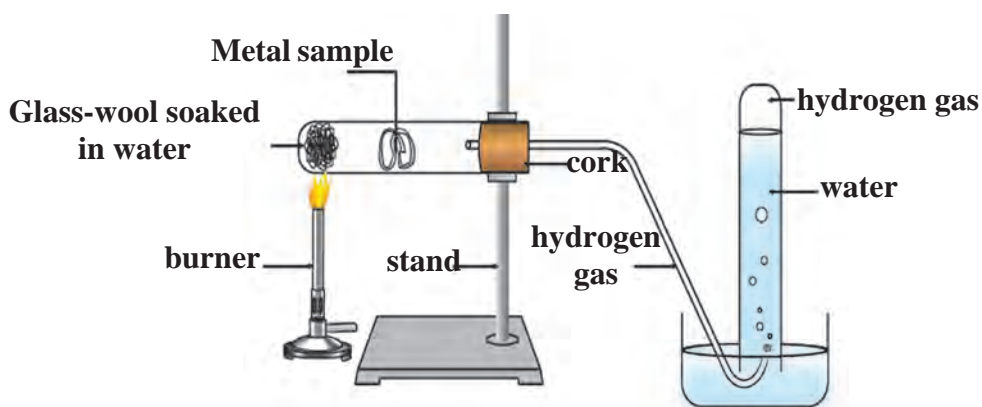

## 8.2 Reaction of a metal with water



**Try out and think about it**

Test whether the metals gold, silver and copper react with water and think over the finding.

### c. Reaction of metals with oxygen

In the earlier chapter we have looked into reaction of metals with acids. Are all the metals equally reactive?

When samples of aluminium, magnesium, iron or zinc are treated with dilute sulphuric or hydrochloric acid, sulphate or chloride salts of metals are formed. Hydrogen gas is liberated in this reaction. The reactivity of these metals can be indicated by the following sequence.

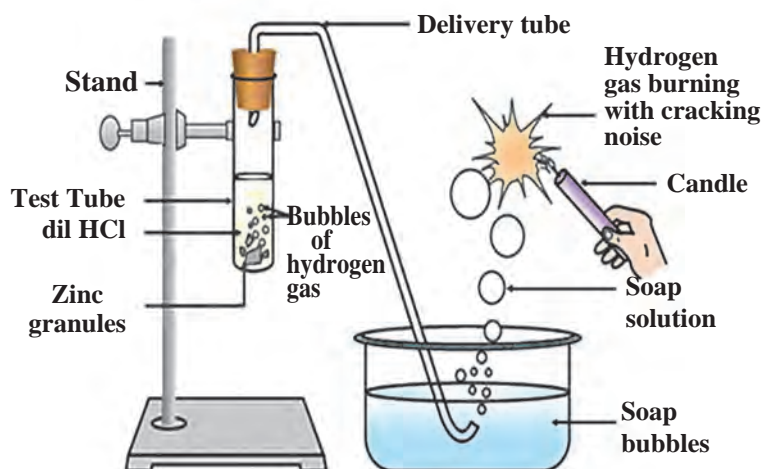
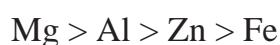

## 8.3 Reaction of metals with dilute acid



#### d. Reaction of metals with nitric acid

Nitrate salts of metals are formed on reaction of metals with nitric acid. Various oxides of nitrogen ( $\text{N}_2\text{O}$ ,  $\text{NO}$ ,  $\text{NO}_2$ ) are also formed in accordance with the concentration of nitric acid.

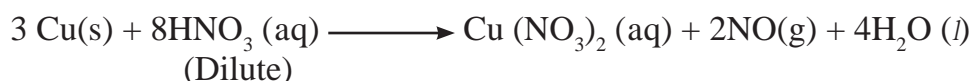
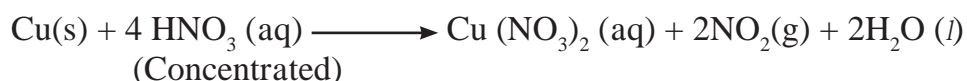

**Aqua Regia:** Aqua regia is a highly corrosive and fuming liquid. It is one of the few reagents which can dissolve the noble metals like gold and platinum. Aqua regia is freshly prepared by mixing concentrated hydrochloric acid and concentrated nitric acid in the ratio 3:1.

#### e. Reaction of metals with salts of other metals



**Try this.**

**Apparatus:** Copper wire, iron nail, beaker or big test tube etc.

**Chemicals:** Aqueous solutions of ferrous sulphate and copper sulphate.

#### Procedure:

1. Take a clean copper wire and a clean iron nail.
2. Dip the copper wire in ferrous sulphate solution and the iron nail in copper sulphate solution.
3. Keep on observing continually at a fixed interval of time.
  - a. In which test tube a reaction has taken place?
  - b. How did you recognize that a reaction has taken place?
  - c. What is the type of the reaction?

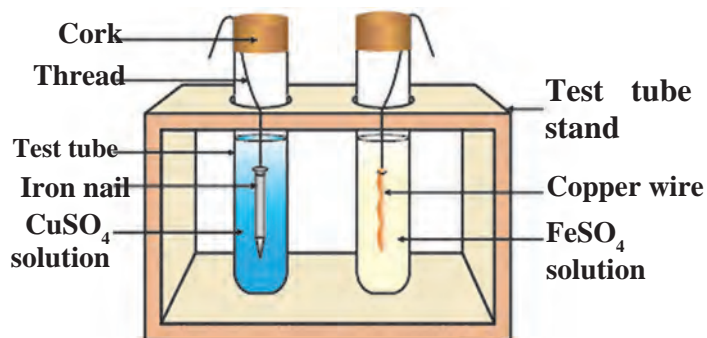

#### 8.4 Reaction of metal with solution of salts of other metals

#### Reactivity series of metals

We have seen that reactivity of all metals is not the same. However, the reagents oxygen, water and acids are not useful to determine the relative reactivities of all the metals, as all the metals do not react with them. The displacement reaction of metals with solutions of salts of other metals serves this purpose. If a metal A displaces another metal B from the solution of its salt then it means that the metal A is more reactive than the metal B.





Answer from your observations in the previous activity 8.4, which metal is more reactive, copper or iron?

In the previous activity, iron has displaced copper from copper sulphate. It means that metallic iron is more reactive than metallic copper.

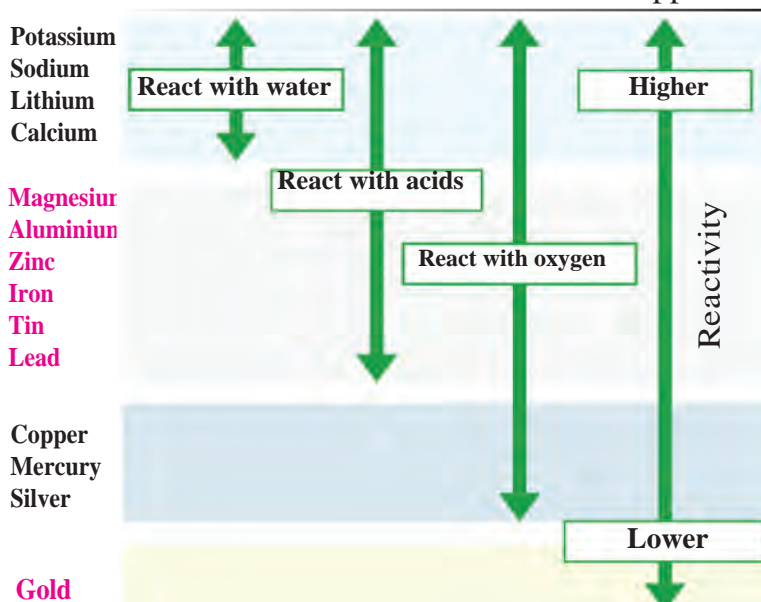

**8.5 Reactivity series of metals.**

Scientists have developed the reactivity series by doing many experiments of displacement reaction. The arrangement of metals in the increasing or decreasing order of reactivity is called the reactivity series of metals. Metals are divided into the following groups according to their reactivity.

1. Highly reactive metals.
2. Moderately reactive metals.
3. Less reactive metals.

#### f. Reaction of metals with nonmetals

Noble gases (like helium, neon, argon) do not take part in the chemical reactions. So far, we have seen from the reactions of metals that cations are formed by oxidation of metals. If we look into the electronic configuration of some metals and nonmetals, it will be seen that the driving force behind a reaction is to attain the electronic configuration of the nearest noble gas with complete octet. Metals do this by losing electrons while nonmetals do this by gaining electrons. The outermost shell of noble gases being complete, they are chemically inert.

You have seen in the last standard that the ionic compound sodium chloride is formed as sodium metal gives away one electron while the nonmetal chlorine takes up one electron.

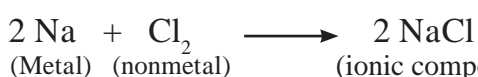

Similarly, magnesium and potassium form the ionic compounds  $\text{MgCl}_2$  and  $\text{KCl}$ , respectively.

#### Chemical properties of nonmetals

Nonmetals are a collection of elements having less similarity in physical and chemical properties. Nonmetals are also called electronegative elements, as they form negatively charged ions by accepting electron. Some examples of chemical reactions of nonmetals are as follows.

##### 1. Reaction of nonmetals with oxygen:

Generally, nonmetals combine with oxygen to form acidic oxides.

In some cases, neutral oxides are formed.

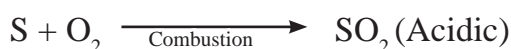
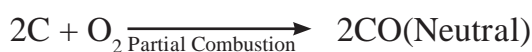
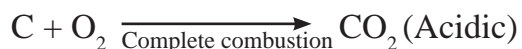

**2. Reaction of nonmetals with water :** Generally, nonmetals do not react with water, except the halogens. For example, chlorine on dissolving in water gives the following reaction.



**3. Reaction of dilute acids with nonmetals :** Generally, nonmetals do not react with dilute acids, halogens are exception to this. For example, chlorine reacts with dilute hydrobromic acid by the following reaction.



**4. Reaction of nonmetals with hydrogen :**

Nonmetals react with hydrogen under certain condition (such as proper temperature, pressure, use of catalyst, etc.)

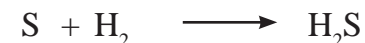

**Use your brain power !**

In the reaction between chlorine and HBr a transformation of HBr into  $\text{Br}_2$  takes place. Can this transformation be called oxidation? Which is the oxidant that brings about this oxidation?

### Ionic compounds

The compounds formed from two units, namely cation and anion are called ionic compounds. The cation and anion being oppositely charged, there is an electrostatic force of attraction between them. You know that, this force of attraction between cation and anion is called as the ionic bond. The number of cations and anions in a compound and the magnitude of the electric charge on them is such that the positive and negative charges balance each other. As a result, an ionic compound is electrically neutral.

Ionic compounds are crystalline in nature. The surfaces of all the particles of a crystalline substance have a definite shape and are smooth and shiny. The regular arrangement of ions in the solid ionic compounds is responsible for their crystalline nature. The arrangement of ions is different in different ionic compounds, and therefore the shapes of their crystals are different. The main factor that determines the general arrangement of ions in a crystal is the attractive force between oppositely charged ions and the repulsive force between similarly charged ions. Because of this the general crystalline structure has negative ions arranged around a positive ion and positive ions arranged around a negative ion. Two of the important factors responsible for a certain crystal structure are as follows.

- 1) Size of the positively and negatively charged ions.
- 2) Magnitude of the electrical charge on the ions.

The electrostatic attraction in the neighbouring ions with opposite charges is very strong. That is why the melting points of ionic compounds are high. Also, the ionic compounds are hard and brittle.

### Properties of ionic compounds



**Try this.**

**Apparatus:** Metal spatula, burner, carbon electrodes, beaker, cell, lamp, press key, electrical wires, etc.

**Chemicals:** Samples of sodium chloride, potassium iodide and barium chloride, water.

**Procedure:** Observe the above samples. Place sample of one of the above salts on the spatula and heat it on flame of the burner. Repeat the procedure using the other salts. As shown in the figure, assemble an electrolyte cell. Assemble an electrolytic cell by using a beaker and connecting the carbon electrodes to the positive and negative terminal of the cell. Dip the electrodes in solution of any one of the salts. Do you see the lamp glowing? Check this with all the other salts as well.

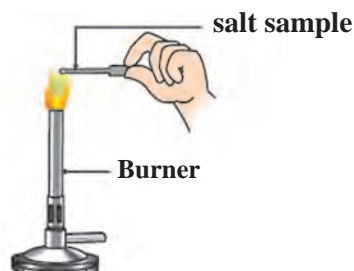

a. To heat salt sample

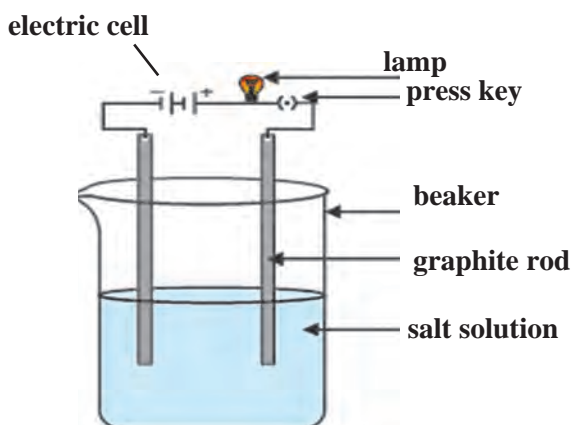

b. To check conductivity of salt solution

### 8.6 To verify the properties of ionic compounds

5. The ionic compounds cannot conduct electricity when in solid state. In this state the ions cannot leave their places. However, in the fused/molten state they can conduct electricity, as in this state the ions are mobile. The aqueous solutions of ionic compounds conduct electricity as they contain the dissociated ions. On passing current through the solution the ions move to the oppositely charged electrodes. Due to the electrical conductivity in fused and dissolved state the ionic compounds are called electrolytes.

### General properties of ionic compounds

1. The attractive force between the positively and negatively charged ions is strong. Therefore, the ionic compounds exist in solid state and are hard.
2. The ionic compounds are brittle and can be broken into pieces by applying pressure.
3. The intermolecular force of attraction is high in ionic compounds and, large energy is required to overcome it. Therefore, the melting and boiling points of ionic compounds are high. (see table 8.7)
4. Ionic compounds are water soluble. This is because the water molecules orient in a particular manner around the ions separated by dissociation process. As a result of this a new force of attraction is established between the ion and the surrounding water molecules, replacing the original intermolecular attraction; and aqueous solutions of ionic compounds are formed. Ionic compounds are however, insoluble in solvents like kerosene and petrol. This is because unlike water a new attractive force can not be established in these solvents.

Compound	ionic/ nonionic	Melting point $^{\circ}\text{C}$	Boiling point $^{\circ}\text{C}$
$\text{H}_2\text{O}$	nonionic	0	100
$\text{ZnCl}_2$	ionic	290	732
$\text{MgCl}_2$	ionic	714	1412
$\text{NaCl}$	ionic	801	1465
$\text{NaBr}$	ionic	747	1390
$\text{KCl}$	ionic	772	1407
$\text{MgO}$	ionic	2852	3600

### 8.6 Melting and boiling points of some ionic compounds

### Metallurgy

The science and technology regarding the extraction of metals from ores and their purification for the use is called metallurgy.

### Occurrence of metals

Most metals being reactive do not occur in nature in free state but are found in combined state as their salts such as oxides, carbonates, sulphides and nitrates. However, the most unreactive metals that are not affected by air, water and other natural factors like silver, gold, platinum, generally occur in free state. The compounds of metals that occur in nature along with the impurities are called minerals.

The minerals from which the metal can be separated economically are called ores. Ores contain many types of impurities such as soil, sand and rocky substances along with the metal compounds. These impurities are called gangue. Metals can be extracted from their ores by means of various methods of separation. The process of extraction of metal in pure state from the ores is also a part of metallurgy.

Ores are taken out from the mines and the gangue is usually separated from the ore at the site itself by various methods. Then the ores are carried out to the place where metals are produced. There metals are extracted in pure form. Then metals are further purified by different methods of purification. This entire process is called metallurgy.

### Basic principles of metallurgy

Pure metal is obtained from the ore by the following stages.

#### 1. Concentration of ores

The process of separating gangue from the ores is called concentration of ores. In this process the concentration of the compound of the desired metal is increased. Various ways are used for this purpose. However, exact way to be used depends upon the physical properties of the metal present in the ores and the gangue. It also depends upon the reactivity of the metal and the facilities available for the purification. Various factors that could be responsible for the environmental pollution are also considered. Some general methods for the concentration of ores are as follows.

##### a. Separation based on gravitation

The heavy particles of ores can be easily separated from the light particles of gangue by the gravitational method. The processes to carry out this separation are as follows.

##### i. Wilfley table method

In this method of separation, the Wilfley table is made by fixing narrow and thin wooden riffles on inclined surface. The table is kept vibrating continuously. Powdered ore obtained from lumps of the ore using ball mill is poured on the table and a stream of water is also released from the upper side. As a result, the lighter gangue particles are carried away along with the flowing water, while the heavier particles in which proportion of minerals is more and proportion of gangue is less, are blocked by the wooden riffles and get collected on the slits between them.

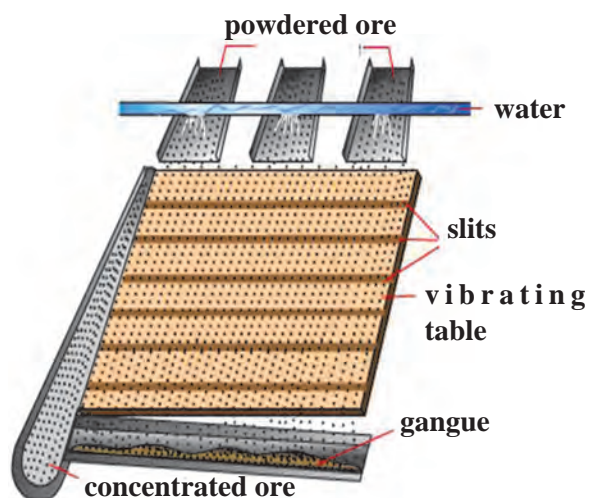

#### 8.8 Wilfley table method

##### ii. Hydraulic separation method

The hydraulic separation method is based on the working of a mill. There is a tapering vessel similar to that used in a grinding mill. It opens in a tank-like container that is tapering on the lower side. The tank has an outlet for water on the upper side and a water inlet on the lower side.



Finely ground ore is released in the tank. A forceful jet of water is introduced in the tank from the lower side. Gangue particles are lighter and therefore they flow out along with the water jet from the outlet on the upper side of the tank and get collected separately. At the same time the heavy particles of the ore are collected at the bottom from the lower side of the tank. In short, this method is based on the law of gravitation, wherein particles of the same size are separated by their weight with the help of water.

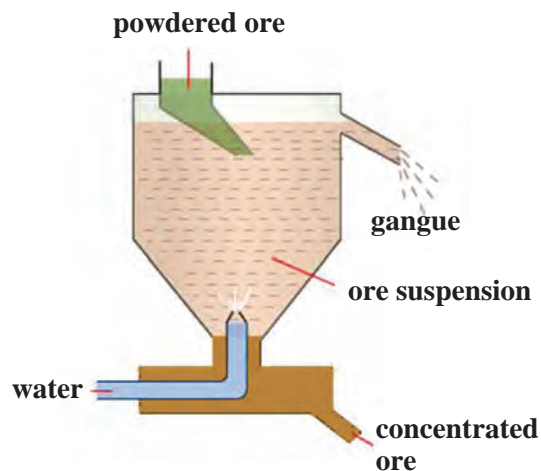

**8.9 Hydraulic separation**

**b. Magnetic separation Method :** This method requires an electromagnetic machine. The main parts of this machine are two types of iron rollers and the conveyor belt moving continuously around them. One of the rollers is nonmagnetic while the other is electromagnetic. The conveyor belt moving around the rollers is (nonmagnetic) made up of leather or brass. The powdered ore is poured on the conveyor belt near the nonmagnetic roller. Two collector vessels are placed below the magnetic roller.

The particles of the nonmagnetic part in the ore are not attracted towards the magnetic roller. Therefore, they are carried further along the belt and fall in the collector vessel places is away from the magnetic roller. At the same time the particles of the magnetic ingredients of the ore stick to the magnetic roller and therefore fall in the collector vessel near the magnetic roller.

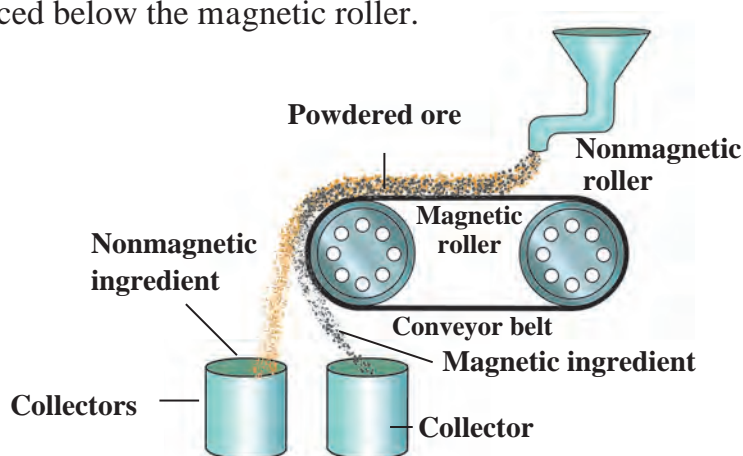

**8.10 Magnetic separation**

In this way the magnetic and nonmagnetic ingredients in the ore can be separated depending on their magnetic nature. For example, cassiterite is a tin ore. It contains mainly the nonmagnetic ingredient stannic oxide ( $\text{SnO}_2$ ) and the magnetic ingredient ferrous tungstate ( $\text{FeWO}_4$ ). These are separated by the electromagnetic method.

**c. Froth floatation method**

The froth floatation method is based on the two opposite properties, hydrophilic and hydrophobic, of the particles. Here the particles of the metal sulphides, due to their hydrophobic property, get wetted mainly with oil, while due to the hydrophilic property the gangue particles get wetted with water. By using these properties certain ores are concentrated by froth floatation method.

**Internet my friend**

Collect the information about the different steps of metal extraction & explain it in the class.

Collect the related videos.

In this method the finely ground ore is put into a big tank containing ample amount of water. Certain vegetable oil such as pine oil, eucalyptus oil is added in the water for the formation of froth. Pressurised air is blown through the water. There is an agitator rotating around its axis in the centre of the floatation tank. The agitator is used as per the requirement. Bubbles are formed due to the blown air. Due to agitation a foam is formed from oil, water and air bubbles together, due to the agitating. This foam rises to the surface of water and floats. That is why this method is called froth floatation process.

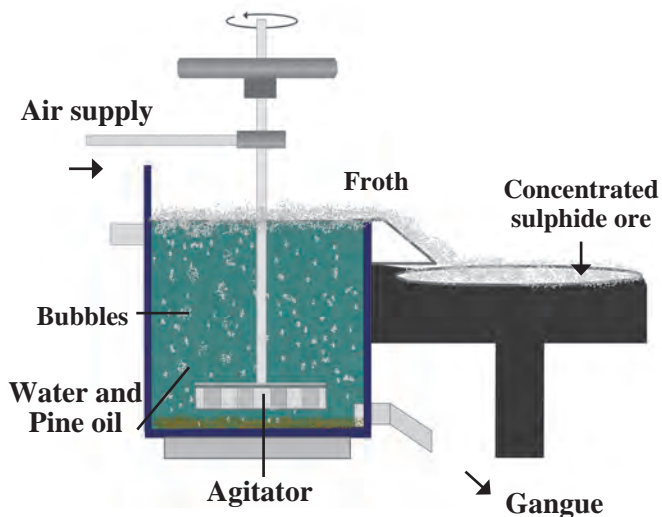

### 8.11 Froth floatation method

Particles of certain sulphide ore float with the foam on water as they preferentially get wetted by the oil. For example, this method is used for the concentration of zinc blend ( $ZnS$ ) and copper pyrite ( $CuFeS_2$ )

#### d. Leaching

The first step in the extraction of the metals aluminium, gold and silver from their ores is the method of leaching. In this method the ore is soaked in a certain solution for a long time. The ore dissolves in that solution due to a specific chemical reaction. The gangue, however, does not react and therefore does not dissolve in that solution. So it can be separated. For example, concentration of bauxite, the aluminium ore, is done by leaching method. Here bauxite is soaked in aqueous  $NaOH$  or aqueous  $Na_2CO_3$  which dissolves the main ingredient alumina in it.



#### Do you know ?

Water does not stick to colocasia leaves. Similarly, water does not stick to wax. On the other hand common salt or soap stick to water that is, they get wetted by water.



#### Can you recall?

What is the electronic definition of oxidation and reduction?

During the extraction of metals from their ores, metal is obtained from the cation of metal. In this process the metal cation is to be reduced. How to bring about the reduction depends upon the reactivity of the metal. We have already learnt about the reactivity series of metals.

## 2. Extraction of metals

### a. Extraction of reactive metals

The metals at the top of the reactivity series are highly reactive. Their reactivity decreases down the series. For example, potassium, sodium, aluminium are reactive metals. Reactive metals have large capacity to form cations by losing the electrons in their outermost shell. For example, reactive metals react vigorously with dilute acids to give hydrogen gas. Highly reactive metals burn by reacting with oxygen from air at room temperature. Their extraction has to be done by electrolytic reduction. For example, the metals sodium, calcium and magnesium are obtained by electrolysis of their molten chloride salts. In this process metal is deposited on the cathode while chlorine gas is liberated at the anode. The electrode reactions during the electrolysis of molten sodium chloride to get metallic sodium are as shown below.

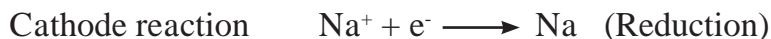

**Use your brain power !**

Write the electrode reaction for electrolysis of molten magnesium chloride and calcium chloride.

We are now going to see how aluminium is obtained by electrolytic reduction of aluminium oxide in the ore bauxite.

### Extraction of Aluminium.

**Aluminium Symbol : Al    Colour : Silver white**  
**Atomic number : 13        Electronic configuration: 2, 8, 3    Valency : 3**

Aluminium being reactive metal does not occur in nature in free state. Aluminium is the third highly abundant element in the earth crust after oxygen and silicon. Aluminium is extracted from its ore bauxite ( $\text{Al}_2\text{O}_3 \cdot n\text{H}_2\text{O}$ ). Bauxite contains 30% to 70% of  $\text{Al}_2\text{O}_3$  and remaining part is gangue. It is made up of sand, silica, iron oxide etc. There are two steps in the extraction of aluminium.

#### i. Concentration of bauxite ore:

Bauxite is the main ore of aluminium. Silica ( $\text{SiO}_2$ ), ferric oxide ( $\text{Fe}_2\text{O}_3$ ) and titanium oxide ( $\text{TiO}_2$ ) are the impurities present in bauxite. Separation of these impurities is done by leaching process using either Bayer's method or Hall's method. In both these methods finally the concentrated alumina is obtained by calcination.

In the Bayer's process the ore is first ground in a ball mill. Then it is leached by heating with concentrated solution of caustic soda ( $\text{NaOH}$ ) at 140 to 150 °C under high pressure for 2 to 8 hours in a digester. Aluminium oxide being amphoteric in nature, it reacts with the aqueous solution of sodium hydroxide to form water soluble sodium aluminate. This means that bauxite is leached by sodium hydroxide solution.

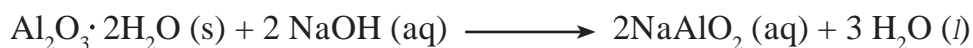

The iron oxide in the gangue does not dissolve in aqueous sodium hydroxide. It is separated by filtration. However, silica in the gangue dissolves in aqueous sodium hydroxide to form water soluble sodium silicate.

Aqueous sodium aluminate is diluted by putting in water and is cooled to 50 °C. This results in precipitation of aluminium hydroxide.



In the Hall's process the ore is powdered and then leached by heating with aqueous sodium carbonate in the digester to form water soluble sodium aluminate. Then the insoluble impurities are filtered out. The filtrate is warmed and neutralised by passing carbon dioxide gas through it. This results in the precipitation of aluminium hydroxide.

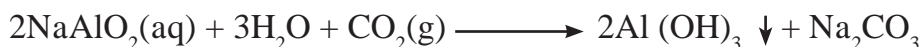
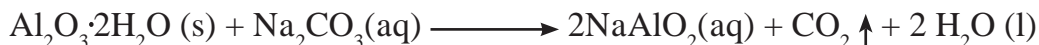

The precipitate of  $\text{Al}(\text{OH})_3$  obtained in both, Bayer's and Hall's processes is filtered, washed, dried and then calcined by heating at  $1000^\circ\text{C}$  to obtain alumina.

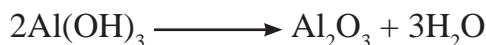

## ii. Electrolytic reduction of alumina

a. In this method electrolysis of molten mixture of alumina (melting point  $> 2000^\circ\text{C}$ ) is done in a steel tank. The tank has a graphite lining on the inner side. This lining does the work of a cathode. A set of graphite rods dipped in the molten electrolyte works as anode. Cryolite ( $\text{Na}_3\text{AlF}_6$ ) and fluorspar ( $\text{CaF}_2$ ) are added in the mixture to lower its melting point up to  $1000^\circ\text{C}$ .

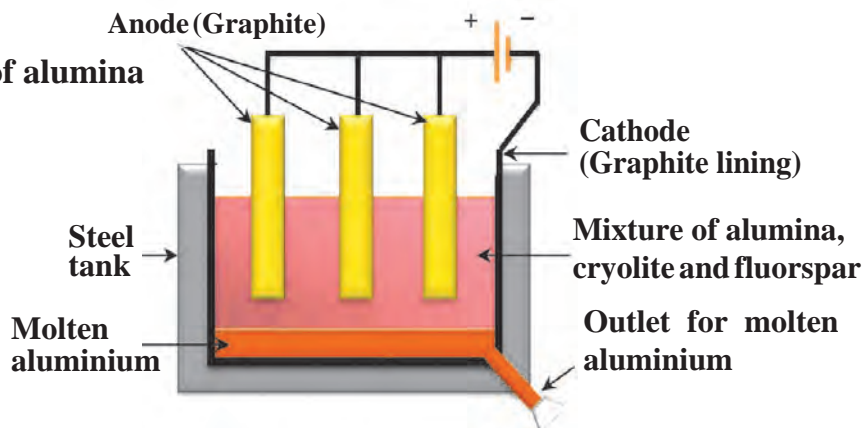

### 8.12 Extraction of aluminium

b. Aluminium is deposited on the cathode on passing electric current. Molten aluminium being heavier than the electrolyte, is collected at the bottom of the tank. It is taken out from there from time to time, Oxygen gas is liberated at the anode.

The electrode reactions are as shown below.

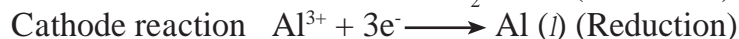

The liberated oxygen reacts with the anodes to form carbon dioxide gas. The anodes have to be changed from time to time as they get oxidised during the electrolysis of alumina.

## b. Extraction of moderately reactive metals



**Can you tell?**

1. What are the moderately reactive metals?
2. In which form do the moderately reactive metals occur in nature?

The metals in the middle of the reactivity series such as iron, zinc, lead, copper are moderately reactive. Usually they occur in the form of their sulphide salts or carbonate. It is easier to obtain metals from their oxides rather than sulphides or carbonates. Therefore, the sulphide ores are strongly heated in air to transform them into oxides. This process is called **roasting**. Carbonate ores are strongly heated in a limited supply of air to transform them into oxides. This process is called **calcination**.

The following reactions occur during roasting and calcination of zinc ore.





The zinc oxide so obtained is reduced to zinc by using suitable reductant such as carbon.



Apart from carbon, reactive metals such as sodium, calcium, aluminium are also used as reducing agent for the reduction of metal oxide to obtain the metal. This is because these metals displace a moderately reactive metal from its compound. For example, when manganese dioxide is ignited with aluminium powder the following reaction takes place.



**Identify the substances undergone oxidation and reduction in this reaction.**

The heat evolved in the above reaction is so large that the metal is formed in the molten state. Another similar example is the thermit reaction. Here, iron oxide reacts with aluminium to form iron and aluminium oxide.

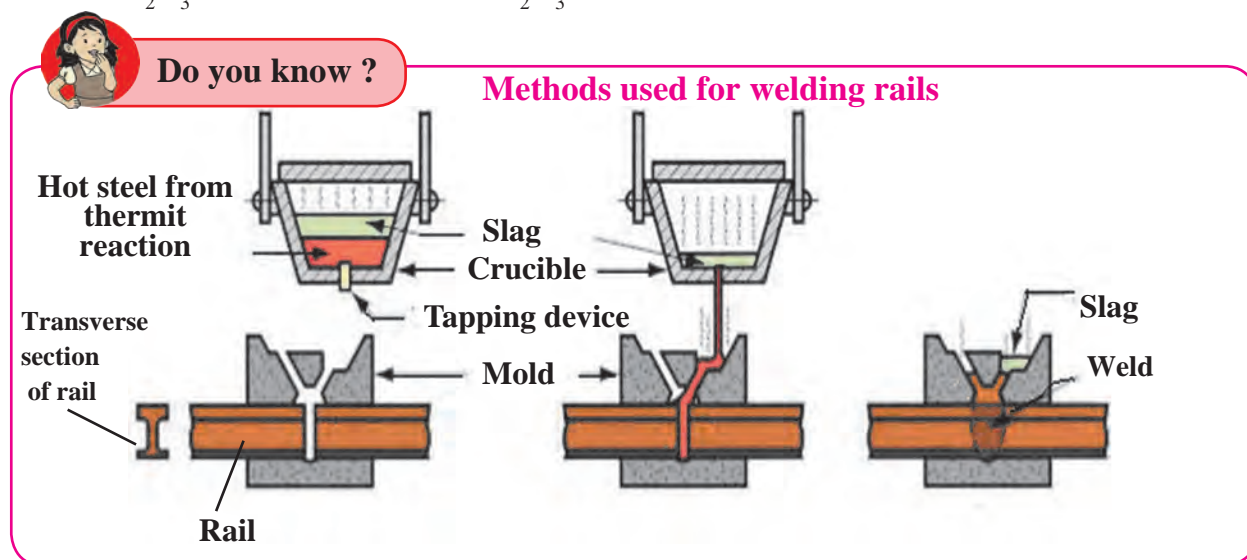

### 8.13 Thermit Welding

#### c. Extraction of less reactive metals

The metals at the bottom of the reactivity series of metals are less reactive. That is why they are found in free state in nature. For example gold, silver, platinum. The reserves of copper in free state are very few. Presently copper is found mainly in the form of  $\text{Cu}_2\text{S}$ .

Copper is obtained from  $\text{Cu}_2\text{S}$  ore just by heating in air.



#### Collect information

Collect the information regarding how mercury is extracted from its ore cinnabar and write the corresponding chemical reaction.

### 3. Refining of metals

Metals obtained by the various reduction processes described above are not very pure. They contain impurities. The impurities need to be separated to obtain pure metal. Electrolysis method is used to obtain pure metals from impure metals.

## Corrosion of metals



### Can you recall?

1. What is meant by corrosion?
2. Have you seen the following things?

Old iron bars of buildings, copper vessels not cleaned for long time, silver ornaments or idols exposed to air for long time, old abandoned vehicles fit to be thrown away.



### Think about it

- 1) Why do silver articles turn blackish while copper vessels turn greenish on keeping in air for a long time?
- 2) Why do pure gold and platinum always glitter?

Rusting of iron articles causes large financial loss. Thus corrosion of iron, that is, rusting is a big problem.

1. Iron reacts with moist air and a deposit of reddish substance ( $\text{Fe}_2\text{O}_3 \cdot \text{H}_2\text{O}$ ) is formed on it. This substance is called rust.
2. Carbon dioxide in moist air reacts with the surface of copper vessel. Copper loses its luster due to formation of greenish layer of copper carbonate ( $\text{CuCO}_3$ ) on its surface. This is called patination of copper.
3. On exposure to air, silver articles turn blackish after some time. This is because of the layer of silver sulphide ( $\text{Ag}_2\text{S}$ ) formed by the reaction of silver with hydrogen sulphide in air.
4. By oxidation of aluminium, a thin layer of aluminium oxide forms on it.



Blackened silver vessel



Rusted shackles



The copper cladded statue of Liberty made 300 years ago has turned green.

## 8.14 Effects of corrosion

### Prevention of corrosion



### Can you tell?

1. Which measures would you suggest to stop the corrosion of metallic articles or not to allow the corrosion to start?
2. What is done so to prevent rusting of iron windows and iron doors of your house?

Various methods are used to protect metals from corrosion. Special attention is paid in almost all the methods so that iron does not rust. We can lower the rate of the process of rusting of iron. Corrosion of metals can be stopped by keeping metals isolated from a direct contact with air. The prevention of corrosion can be achieved by various ways. Some of these methods are as follows.

1. To fix a layer of some substance on the metal surface so that the contact of the metal with moisture and oxygen in the air is prevented and no reaction would occur between them.

2. To prevent corrosion of metals by applying a layer of paint, oil, grease or varnish on their surface. For example, corrosion of iron can be prevented by this method.



### Use your brain power !

Can we permanently prevent the rusting of an iron article by applying a layer of paint on its surface?

We cannot protect the articles permanently from rusting by painting them. The method of painting is suitable for short time. If there is a scratch on the paint on the surface of the article and if a small surface of the metal comes in contact with air, the process of rusting starts below the layer of the paint.

Why do new iron sheets appear shiny?

Corrosion can be prevented by putting a layer of noncorrodible metal on a corrodible metal. This can be done in many ways.

### 1. Galvanizing

In this method a thin layer of zinc is applied to prevent corrosion of iron or steel. For example, shining iron nails, pins, etc. In this method corrosion of zinc occurs first because zinc is more electropositive than iron. After a few rainy seasons the zinc layer goes away and the inner iron gets exposed. Then iron starts rusting.

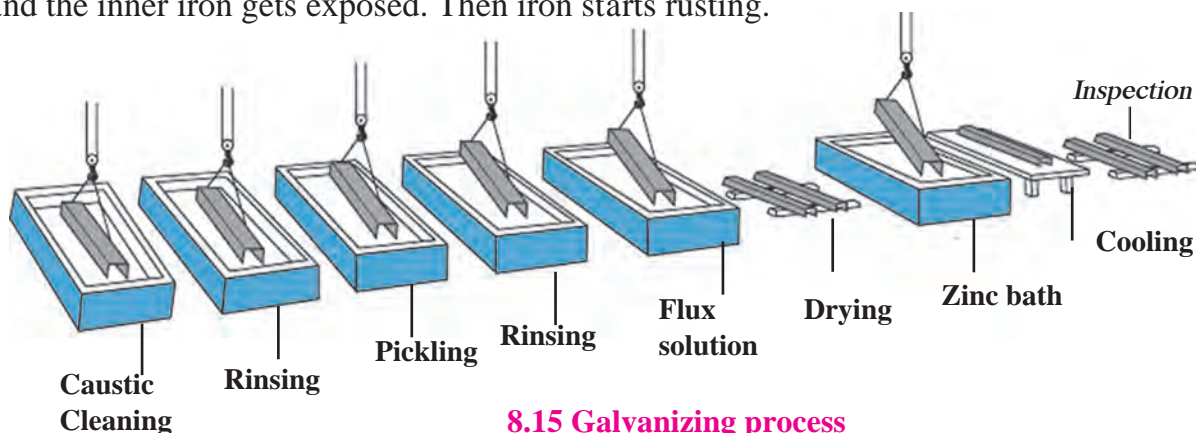

8.15 Galvanizing process

### 2. Tinning

In this method a layer of molten tin is deposited on metals. We call this as 'kalhae'. A greenish layer forms on the surface of a copper or brass vessel. This greenish layer is poisonous. If buttermilk or curry is placed in such a vessel it gets spoiled. Tinning is done to prevent all such damages.

### 3. Anodization

In this method metals like copper, aluminium are coated with a thin and strong layer of their oxides by means of electrolysis. For this the copper or aluminium article is used as anode. As this oxide layer is strong and uniform all over the surface, it is useful for prevention of the corrosion of the metal.

For example, when aluminium is anodised, the thin layer of aluminium oxide is formed. It obstructs the contact of the aluminium with oxygen and water. This prevents further oxidation. This protection can be further increased by making the oxide layer thicker during the anodization.

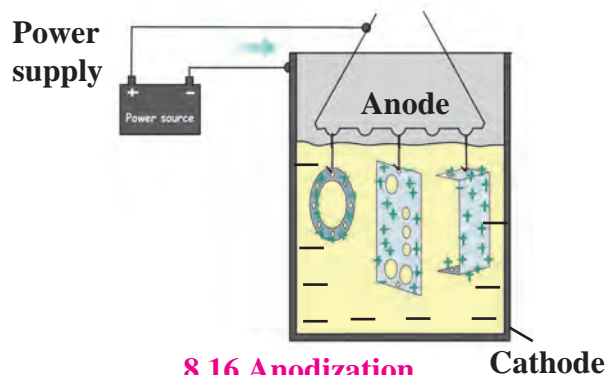

8.16 Anodization

#### 4. Electroplating

In this method a less reactive metal is coated on a more reactive metal by electrolysis. Silver plated spoons, gold plated ornaments are the examples of electroplating.

#### 5. Alloying

Majority of the metallic substances used presently are in the form of alloys. The main intention behind this is to decrease the intensity of corrosion of metals. The homogenous mixture formed by mixing a metal with other metals or nonmetals in certain proportion is called an alloy. For example, bronze is an alloy formed from 90% copper and 10 % tin. Bronze statues do not get affected by sun and rain. Stainless steel does not get stains with air or water and also does not rust. It is an alloy made from 74% iron, 18% chromium and 8% carbon. In recent times various types of alloys are used for minting coins.

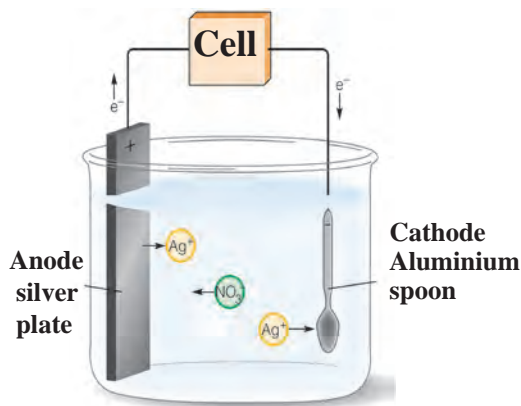

8.17 Electroplating



8.18 Coins made from various alloys



#### Do you know ?

When one of the metals in an alloy is mercury the alloy is called amalgam. For example, sodium amalgam, zinc amalgam, etc. Silver amalgam was earlier used by dentists. Gold amalgam is used for extraction of gold.



#### Collect information

1. What are the various alloys used in daily life? Where are those used?
2. What are the properties that the alloy used for minting coins should have?

### Exercise



#### 1. Write names.

- a. Alloy of sodium with mercury.
- b. Molecular formula of the common ore of aluminium.
- c. The oxide that forms salt and water by reacting with both acid and base.
- d. The device used for grinding an ore.
- e. The nonmetal having electrical conductivity.
- f. The reagent that dissolves noble metals.

#### 2. Make pairs of substances and their properties

Substance	Property
a. Potassium bromide	1. Combustible
b. Gold	2. Soluble in water
c. Sulphur	3. No chemical reaction
d. Neon	4. High ductility.



3. Identify the pairs of metals and their ores from the following.

**Group A**

- a. Bauxite
- b. Cassiterite
- c. Cinnabar

**Group B**

- i. Mercury
- ii. Aluminium
- iii. Tin

4. Explain the terms.

- a. Metallurgy
- b. Ores
- c. Minerals
- d. Gangue.

5. Write scientific reasons.

- a. Lemon or tamarind is used for cleaning copper vessels turned greenish.
- b. Generally the ionic compounds have high melting points.
- c. Sodium is always kept in kerosene.
- d. Pine oil is used in froth flotation.
- e. Anodes need to be replaced from time to time during the electrolysis of alumina.

6. When a copper coin is dipped in silver nitrate solution, a glitter appears on the coin after some time. Why does this happen? Write the chemical equation.

7. The electronic configuration of metal 'A' is 2,8,1 and that of metal 'B' is 2,8,2. Which of the two metals is more reactive? Write their reaction with dilute hydrochloric acid.

8. Draw a neat labelled diagram.

- a. Magnetic separation method.
- b. Froth floatation method.
- c. Electrolytic reduction of alumina.
- d. Hydraulic separation method.

9. Write chemical equation for the following events.

- a. Aluminium came in contact with air.
- b. Iron filings are dropped in aqueous solution of copper sulphate.
- c. A reaction was brought about between ferric oxide and aluminium.
- d. Electrolysis of alumina is done.
- e. Zinc oxide is dissolved in dilute hydrochloric acid.

10. Complete the following statement using every given options.

**During the extraction of aluminium.....**

- a. Ingredients and gangue in bauxite.
- b. Use of leaching during the concentration of ore.
- c. Chemical reaction of transformation of bauxite into alumina by Hall's process.
- d. Heating the aluminium ore with concentrated caustic soda.

11. Divide the metals Cu, Zn, Ca, Mg, Fe, Na, Li into three groups, namely reactive metals, moderately reactive metals and less reactive metals.

**Project:**

Collect metal vessels and various metal articles. Write detailed information. Write the steps in the procedure that can be done in the laboratory for giving glitter to these. Seek guidance from your teacher.



## 9. Carbon Compounds



- Bonds in carbon compounds
- Hydrocarbons, Functional Groups and homologous series
- Chemical Properties of Carbon Compounds
- Carbon : A Versatile Element
- Nomenclature of Carbon compounds
- Macromolecules and Polymers



### Can you recall?

1. What are the types of compounds ?
2. Objects in everyday use such as foodstuff, fibers, paper, medicines, wood, fuels, are made of various compounds. Which constituent elements are common in these compounds?
3. To which group in the periodic table does the element carbon belongs ? Write down the electronic configuration of carbon and deduce the valency of carbon.

In the previous standards we have seen that organic and inorganic compounds are the two important types of compounds. Except materials fabricated from metal and glass/soil several other materials from foodstuff to fuels are made up of organic compounds. The essential element in all the organic compounds is carbon. About 200 years back it was believed that organic compounds are obtained directly or indirectly from the organisms. However, after synthesis of the organic compound urea from an inorganic compounds in the laboratory, the organic compounds received a new identity as carbon compounds. All the compounds having carbon as a constituent element are called as organic compounds. The compounds carbon dioxide, carbon monoxide, carbide salts, carbonate salts and bicarbonate salts are exception; they are inorganic compounds of carbon.

### Bonds in Carbon compounds

You have learnt about the ionic compounds in the previous chapter. You have seen that ionic compounds have high melting and boiling points and they conduct electricity in the molten and dissolved state. You have also seen that these properties of ionic compounds are explained on the basis of the ionic bonds in them. The table 9.1 shows melting and boiling points of a few carbon compounds. Are these values higher or lower as compared to the ionic compounds?

Generally the melting and boiling points of carbon compounds are found to be lower than  $300\text{ }^{\circ}\text{C}$ . From this we understood that the intermolecular attractive forces are weak in carbon compounds.

In the previous standard on testing the electrical conductivity of carbon compounds, glucose and urea you have observed that they are not electrical conductors. Generally most of the carbon compounds are found to be bad conductors of electricity. From it we understand that structures of most of the carbon compounds lack ionic bonds. It means that the chemical bonds in carbon compounds do not produce ions.

Compound	Melting point $^{\circ}\text{C}$	Boiling point $^{\circ}\text{C}$
Methane ( $\text{CH}_4$ )	- 183	- 162
Ethanol ( $\text{CH}_3\text{CH}_2\text{OH}$ )	- 117	78
Chloroform ( $\text{CHCl}_3$ )	- 64	61
Acetic acid ( $\text{CH}_3\text{COOH}$ )	17	118

### 9.1 Melting and Boiling Points of a few carbon compounds



### Can you tell?

1. What is meant by a chemical bond?
2. What is the number of chemical bonds that an atom of an element forms called?
3. What are the two important types of chemical bonds?

In the previous standards you have learnt about the relationship between electronic configuration and valency of an element, and also about the ionic and covalent bonds. Let see at the background of electronic configuration of carbon and the covalent bonds formed. (See Table 9.2).

Carbon atom	Electronic Configuration	Number of electron in the Valence shell	Most nearby noble gas and the electronic configuration	
			He	Ne
${}_6\text{C}$	2, 4	4	2	2,8

### 9.2 Background of bond formation by carbon

You have seen that the driving force behind the formation of bond by an atom is to attain the stable electronic configuration of the nearby noble gas and obtain stability. As the valence shell of carbon contains 4 electrons, there can be many alternative routes to attain a noble gas configuration.

(i) To attain the configuration of noble gas helium (He) by losing one after another all the four valence electrons : In this method the net positive charge on the carbon atom goes on increasing during loss of every electrons. Therefore to lose the next electron more energy is required, which makes the task more difficult. Moreover, the  $\text{C}^{4+}$  cation that would ultimately form in this process becomes unstable in spite of its noble gas configuration, because it has a small size with high net charge. Therefore carbon atom does not take this route to attain a noble gas configuration.

(ii) To attain the stable configuration of the noble gas neon (Ne) by accepting one by one all the four electrons in the valence shell. In this method the net negative charge on the carbon atom goes on increasing while accepting every new electron. Therefore, more energy is required for accepting the next electron by overcoming the increasing repulsive force making the task more and more difficult. Moreover the  $\text{C}^{4-}$  anion ultimately formed would be unstable in spite of its noble gas configuration, as it would have a small size with high net charge making it difficult for the nuclear charge +6 to hold 10 electrons around it. Therefore, carbon atom does not take this route to attain a noble gas configuration.

(iii) To attain the configuration of neon by sharing four electrons of valence shell with four valence electrons of other atoms: In this method two atoms share valence electrons with each other. Valence shells of both the atoms overlap and accommodate the shared electrons, As a result, both the atoms attain a noble gas configuration without generating any net charge on them, which means that atoms remain electrically neutral. Due to these factors atoms attain stability. Therefore, carbon atom adopts this route to attain a noble gas configuration.

The chemical bond formed by sharing of two valence electrons between the two atoms is called covalent bond.

A covalent bond is represented clearly by drawing an electron - dot structure. In this method a circle is drawn around the atomic symbol and each of the valence electrons is indicated by a dot or a cross. The covalent bond formed between the atoms is indicated by showing the circles around the atomic symbols crossing each other. The shared electrons are shown in the overlapping regions of the two circles by dot or cross. The electron - dot structure is also drawn without showing the circle. One pair of shared electrons constitutes one covalent bond . A covalent bond is also represented by a small line joining the symbols of the two atoms. The line structure is also called structural formula.



### 9.3 Electron dot structure and line structure of hydrogen molecule with a single bond

Let us first look at the hydrogen molecule which is the simplest example of a molecule formed by covalent bonding. You have already learnt that the atomic number of hydrogen being 1, its atom contains 1 electron in K shell. It requires one more electron to complete the K shell and attain the configuration of helium (He). To meet this requirement two hydrogen atoms share their electrons with each other to form  $H_2$  molecule. One covalent bond, that is a single bond is formed between two hydrogen atoms by sharing of two electrons. (see fig 9.3).

The  $O_2$  molecule is formed by chemical combination of two oxygen atoms; and  $N_2$  molecule is formed by the chemical combination of two nitrogen atoms. On drawing the electron-dot structures of these two molecules, it becomes clear that the two oxygen atoms in  $O_2$  molecule are joined with each other by two covalent bonds, that is, a double bond, while the two nitrogen atoms in the  $N_2$  molecule are joined with each other by three covalent bonds, that is, a triple bond (See figure 9.4) (Remember that it is essential to show all the valence electrons in an electron dot structure.)

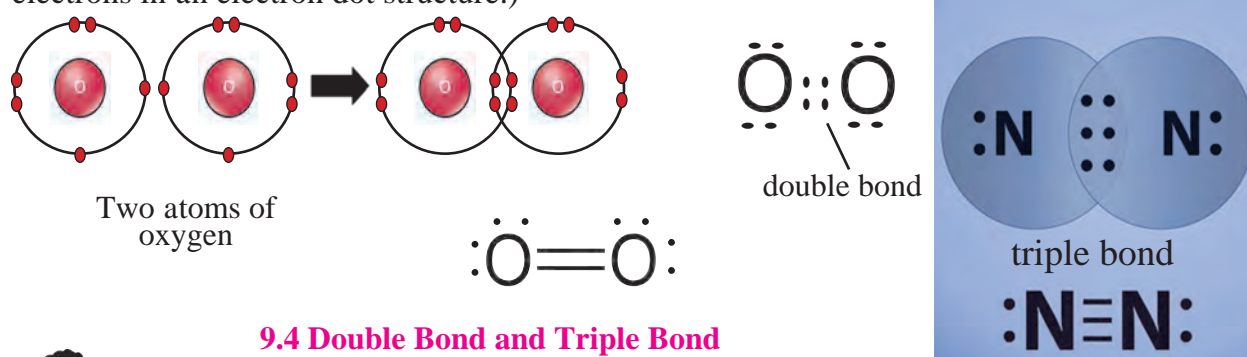

#### 9.4 Double Bond and Triple Bond



#### Use your brain power !

1. Atomic number of chlorine is 17. What is the number of electron in the valence shell of chlorine?
2. Molecular formula of chlorine is  $Cl_2$ . Draw electron-dot and line structure of a chlorine molecule.
3. The molecular formula of water is  $H_2O$ . Draw electron-dot and line structures for this triatomic molecule. (Use dots for electron of oxygen atom and crosses for electrons of hydrogen atoms.)
4. The molecular formula of ammonia is  $NH_3$ . Draw electron-dot and line structures for ammonia molecule.

Now let us consider a carbon compound methane ( $CH_4$ ). You have learnt about the occurrence, properties and uses of methane molecule in the previous standard. Just now we saw that carbon atom forms four covalent bonds using the four valence electrons and attain the configuration of the nearby noble gas neon (Ne) and obtains stability: Fig 9.5 shows the line structure and also the electron-dot structure of methane.



#### Do you know ?

To understand the structures of carbon compounds various types of molecular models are used. The fig 9.6 shows ball and stick model and space filling model of methane molecule.



#### Use your brain power !

1. The molecular formula of carbon dioxide is  $CO_2$ . Draw the electron-dot structure (without showing circle) and line structure for  $CO_2$ .
2. With which bond C atom in  $CO_2$  is bonded to each of the O atoms?
3. The molecular formula of sulphur is  $S_8$  in which eight sulphur atoms are bonded to each other to form one ring. Draw an electron-dot structure for  $S_8$  without showing the circles.



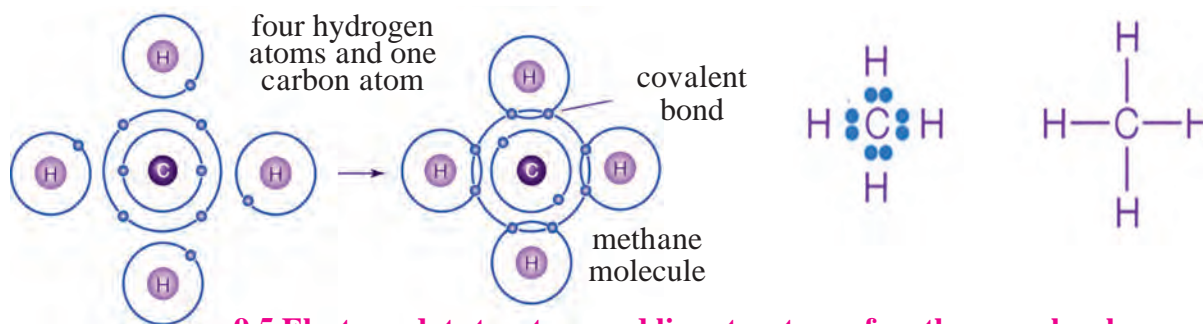

### 9.5 Electron-dot structure and line structure of methane molecule

#### Carbon : A Versatile Element

We saw that carbon atoms, like some other atoms, share the valence electrons to form covalent bonds. Similarly, we also saw the structure of the simple carbon compound, methane. But carbon is different than the other elements; the number of compounds formed from carbon is extremely large. In the beginning we saw that except for the objects formed from metals and glass/soil all the other objects are made from carbon. In short, brief the entire living kingdom is made from carbon, our body is also made from carbon. Millions of molecules ranging from the small and simple methane molecule to the extremely big D.N.A. molecule are made from carbon. The molecular masses of carbon compounds range up to  $10^{12}$ . This means that carbon atoms come together in a large number to form extremely big molecules. What is the cause of this unique property of carbon? It is due to the peculiar nature of the covalent bonds formed by carbon, it can form large number of compounds. From this we come to know the following **characteristics of carbon**.

a. Carbon has a unique ability to form strong covalent bonds with other carbon atoms; this results in formation of big molecules. This property of carbon is called catenation power. The carbon compounds contain open chains or closed chains of carbon atoms. An open chain can be a straight chain or a branched chain. A closed chain is a ring structure. The covalent bond between two carbon atoms is strong and therefore stable. Due to the strong and stable covalent bonds carbon is bestowed with catenation power.

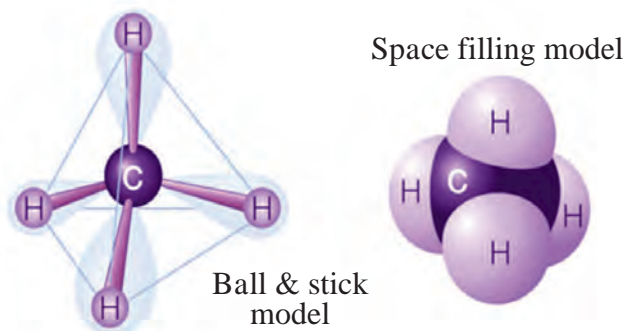

### 9.6 Models of methane molecule

Till now the number of known carbon compounds is about 10 million. This number is larger than the total number of compounds formed by all the other elements. The range of molecular masses of carbon compounds is  $10^1 - 10^{12}$ . (See table 9.7)



#### Use your brain power !

1. Hydrogen peroxide decomposes on its own by the following reaction

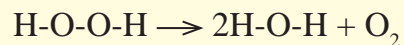

From this, what will be your inference about the strength of O-O covalent bond?

2. Tell from the above example whether oxygen has catenation power or not.

Carbon Compound	Molecular mass
Methane $\text{CH}_4$ (The smallest carbon compound)	16
Cooking gas ( $\text{C}_3\text{H}_8 + \text{C}_4\text{H}_{10}$ )	44/58
Benzene ( $\text{C}_6\text{H}_6$ )	78
Camphor ( $\text{C}_{10}\text{H}_{16}\text{O}$ )	152
Penicillin ( $\text{C}_{16}\text{H}_{18}\text{N}_2\text{O}_4\text{S}$ )	334
Sugar ( $\text{C}_{12}\text{H}_{22}\text{O}_{11}$ )	342
Sodium dodecyl benzene sulphate (a detergent)	347
Fat	~ 700
Starch	~ $10^3$
Cellulose	~ $10^5$
Protein	~ $10^5$
Polyethylene	~ $10^6$
D.N.A.	~ $10^{12}$

b. Two carbon atoms can be bonded together by one, two or three covalent bonds. These are called single bond, double bond, and triple bond respectively. Due to the ability of carbon atoms to form multiple bonds as well as single bonds, the number of carbon compounds increases. For example, there are three compounds, namely, ethane ( $\text{CH}_3\text{-CH}_3$ ), ethene ( $\text{CH}_2=\text{CH}_2$ ) and ethyne ( $\text{CH}\equiv\text{CH}$ ) which contain two carbon atoms.

### 9.7 Carbon compounds and molecular masses

c. Being tetravalent one carbon atom can form bonds with four other atoms (carbon or any other). This results in formation of many compounds. These compounds possess different properties as per the atoms to which carbon is bonded. For example, five different compounds are formed using one carbon atom and two monovalent elements hydrogen and chlorine :  $\text{CH}_4$ ,  $\text{CH}_3\text{Cl}$ ,  $\text{CH}_2\text{Cl}_2$ ,  $\text{CHCl}_3$ ,  $\text{CCl}_4$ . Similarly carbon atoms form covalent bonds with atoms of elements like O, N, S, halogen & P to form different types of carbon compounds in large number.

d. Carbon has one more characteristic which is responsible for large number of carbon compounds. It is 'isomerism'. Shortly, we will learn about it.

### Hydrocarbons : Saturated and Unsaturated

Carbon compounds contain many elements. The element hydrogen is present to a smaller or larger extent in majority of carbon compounds. The compounds which contain carbon and hydrogen as the only two elements are called hydrocarbons. Hydrocarbons are the simplest and the fundamental organic compounds. The smallest hydrocarbon is methane ( $\text{CH}_4$ ) formed by combination of one carbon atom and four hydrogen atoms. We have already seen the structure of methane. Ethane is one more hydrocarbon. Its molecular formula is  $\text{C}_2\text{H}_6$ . The first step in writing the line structure (structural formula) of a hydrocarbon is to join the carbon atoms in the molecule with single bonds, and then in the second step use the hydrogen atoms in the molecular formula so as to fulfil the remaining valencies of the tetravalent carbon atoms. (See fig. 9.8), Fig. 9.9 shows electron-dot structure using two methods.

Ethane : Molecular formula  $\text{C}_2\text{H}_6$

Step 1 : Join the two carbon atoms with single bonds C - C

Step 2 : Use the 6 hydrogen atoms in the molecular formula for fulfilling the tetravalency of both the carbon atoms.

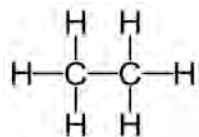

9.8 Line structure / structural formula of ethane

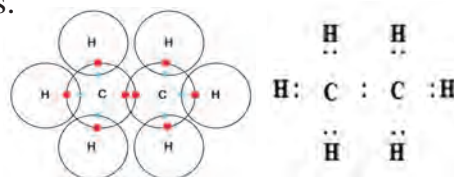

9.9. Electron-dot structure of ethane



**Use your brain power !**

Molecular formula of propane is  $C_3H_8$ . From this draw its structural formula.

From the structural formula of ethane & propane it is seen that the valencies of all the atoms are satisfied by the single bonds. Such compounds are called saturated compounds. Ethane & propane are saturated hydrocarbons. Saturated hydrocarbons are also called 'Alkanes'.

There are two more hydrocarbons that contain two carbon atoms, namely, ethene ( $C_2H_4$ ) and ethyne ( $C_2H_2$ ). Let us see the method to draw the structural formula (line structure) of ethene ( $C_2H_4$ ). (Fig 9.10)

**Step 1 :** Join the two carbon atoms with single bond C-C.

**Step 2 :** Use the 4 hydrogen atoms in the molecular formula for satisfying tetravalency of both the carbon atoms.

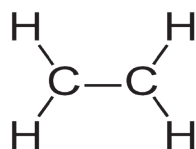

It appears that one valency of each of the two carbon atoms is not satisfied.

**Step 3:** Satisfy the tetravalency of the two carbon atoms by drawing a double bond in place of the single bond between them.

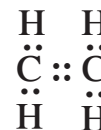
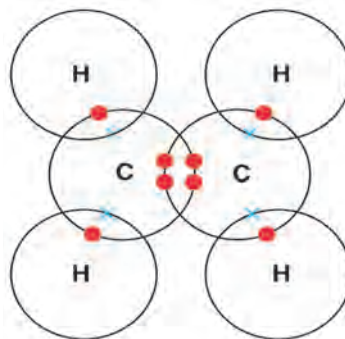
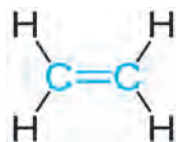

### 9.10 Line structure/ structural formula

### 9.11 Electron-dot structures of ethane



**Use your brain power !**

1. The molecular formula ethyne is  $C_2H_2$ . From this draw its structural formula and electron - dot structure.
2. How many bonds have to be there in between the two carbon atoms in ethyne so as to satisfy their tetravalency?

The carbon compounds having a double bond or triple bond between two carbon atoms are called unsaturated compounds. Ethene and ethyne are unsaturated hydrocarbons. The unsaturated hydrocarbons containing a carbon-carbon double bond are called 'Alkenes'. The unsaturated hydrocarbons whose structures contain a carbon-carbon triple bond are called 'Alkynes'. Generally the unsaturated compounds are more reactive than the saturated compounds.

### Straight chains, Branched chains and Rings of Carbon atoms

Let us compare the structural formulae of methane, ethane and propane. From these structural formulae it is seen that the carbon atom (single or more carbon atoms bonded to each other) lie in the core of the molecule, while the hydrogen atoms bonded to each of the carbon atoms are on the periphery of the molecule. The mutually bonded carbon atoms in the core are like the skeleton of the molecule. The carbon skeleton determines the shape of the molecule of a carbon compound.

A straight chain of carbon atoms is formed by joining the carbon atoms are next to the other. The first column of the table 9.12 shows straight chains of carbon atoms. Write the structural formulae of the corresponding straight chain hydrocarbons in the second column satisfying the tetravalency of the carbon atom by joining them to hydrogen atoms. Work out the molecular formula from this and write it down in the third column. The name of the hydrocarbon is given in the fourth column.

Straight chain of carbon atoms	Structural formula	Molecular formula	Name
C	$\begin{array}{c} \text{H} \\   \\ \text{H}-\text{C}-\text{H} \\   \\ \text{H} \end{array}$	CH <sub>4</sub>	Methane
C-C			Ethane
C-C-C			Propane
C-C-C-C			Butane
C-C-C-C-C			Pentane
C-C-C-C-C-C			Hexane
C-C-C-C-C-C-C			Heptane
C-C-C-C-C-C-C-C			Octane
C-C-C-C-C-C-C-C-C			Nonane
C-C-C-C-C-C-C-C-C-C			Decane



### Do you know ?

In the course of millions of years the reserves of crude oil were formed from the dead organisms buried under the sea floor. This crude oil and natural gas are now recovered from the oil wells. The natural gas is mainly methane. The crude oil is a complex mixture of thousands of different compounds. It mainly contains various hydrocarbons. Various useful components such as CNG, LPG, petrol (gasoline), kerosene, diesel, engine oil, lubricant, etc. are obtained by separation crude oil using fractional distillation.

### 9.12 Straight chain hydrocarbon

Now let us pay more attention to the carbon chain in butane. The four carbon atoms can be joined to form a carbon chain in yet another way. (See fig 9.13 a)

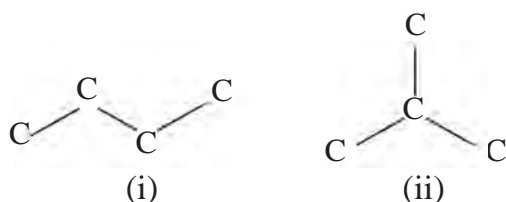

a. Two possible carbon chains

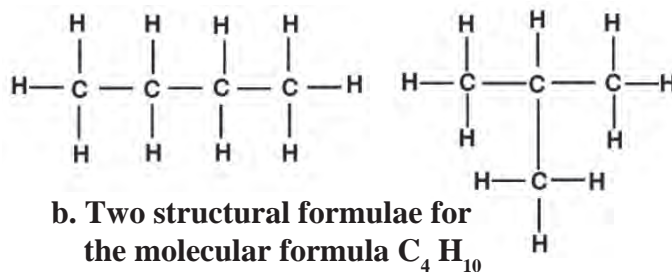

b. Two structural formulae for the molecular formula C<sub>4</sub>H<sub>10</sub>

### 9.13 Two isomeric compounds with molecular formula C<sub>4</sub>H<sub>10</sub>

Two different structural formulae are obtained on joining hydrogen atoms to these two chains so as to satisfy the tetravalency of the carbon atoms. The molecular formula of both these structural formulae is the same which is C<sub>4</sub>H<sub>10</sub>. These are two different compounds as their structural formulae are different. The phenomenon in which compounds having different structural formulae have the same molecular formula is called 'structural isomerism'. The number of carbon compounds increases further due to the isomerism observed in carbon compounds. The carbon chain (i) in the figure 9.13 (a) is a straight chain of carbon atoms, whereas the carbon chain (ii) is a branched chain of carbon atoms.

Apart from the straight chains and branched chains, closed chains of carbon atoms are present in some carbon compounds. Where in rings of carbon atoms form. For example, the molecular formula of cyclohexane is C<sub>6</sub>H<sub>12</sub> and its structural formula contains a ring of six carbon atoms. (See fig 9.14)

#### a. the carbon ring in cyclohexane

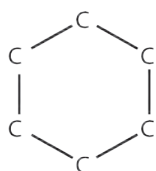

#### b. Structural formula of cyclohexane

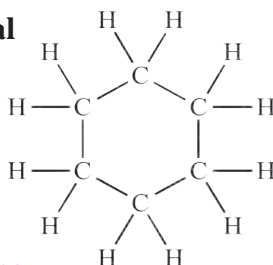

### Use your brain power !

Draw electron-dot structure of cyclohexane.

### 9.14 Ring Structure of Cyclohexane

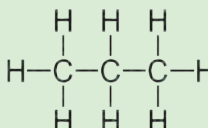
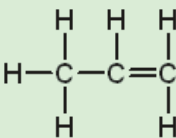
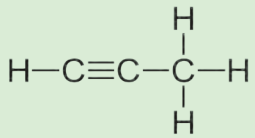
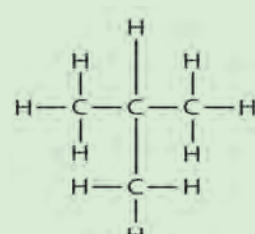
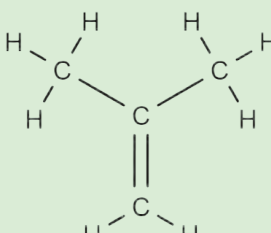
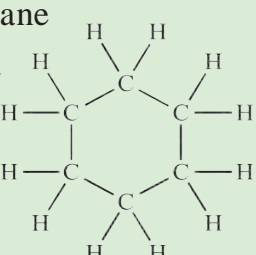
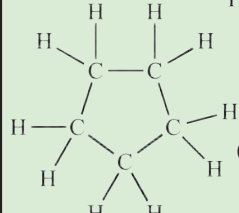
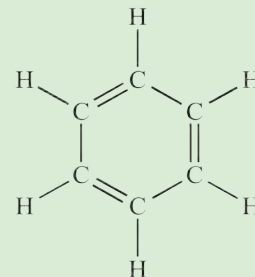
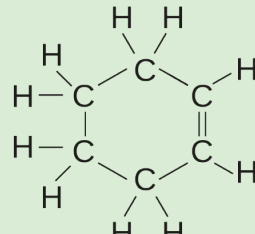

All types of carbon compounds whether straight chain, branched chain or cyclic, can be saturated or unsaturated. This is explained by the various examples of hydrocarbons in table 9.15

	Saturated hydrocarbons	Unsaturated hydrocarbons
Straight chain hydrocarbons	Propane $C_3H_8$ 	 Propene $C_3H_6$  Propyne $C_3H_4$
Branched chain hydrocarbons	isobutane $C_4H_{10}$ 	isobutylene $C_4H_8$ 
Cyclic hydrocarbons	Cyclohexane $C_6H_{12}$   Cyclopentane $C_5H_{10}$	Cyclohexene $C_6H_{10}$   Benzene $C_6H_6$

### 9.15 Various Types of Hydrocarbons

It is learnt from the structural formula of benzene that it is a cyclic unsaturated hydrocarbon. There are three alternate double bonds in the six membered ring structure of benzene. The compounds having this characteristic unit in their structure are called aromatic compounds.

### Functional Groups in Carbon Compounds

Till now you have learnt about the hydrocarbon compounds formed by combination of the elements carbon and hydrogen. Many more types of carbon compounds are formed by formation of bonds of carbon with other elements such as halogens, oxygen, nitrogen, sulphur. The atoms of these elements substitute one or more hydrogen atoms in the hydrocarbon chain and thereby the tetravalency of carbon is satisfied. The atom of the element which is substitute for hydrogen is referred to as a hetero atom. Sometimes hetero atoms are not alone but exist in the form of certain groups of atoms. (See the table 9.16).

The compound acquire specific chemical properties due to these hetero atoms or the groups of atoms that contain heteroatoms, irrespective of the length and nature of the carbon chain in that compound. Therefore these hetero atoms or the groups of atoms containing hetero atoms are called functional groups. The table 9.16 shows a few functional groups that occurs in carbon compounds.

Here the free valency of the functional group is indicated by a short line. The functional group taking place of a hydrogen is joined to the carbon chain with this valency. The **carbon- carbon double and triple bonds** are also recognised as functional groups as the respective compounds get specific chemical properties due to them.

Hetero Atom	Functional Group		
	Name	Structural formula	Condensed Structural formula
Halogen (chlorine, bromine, iodine)	Halo (chromo/ bromo / iodo)	-X (-Cl, -Br, -I)	- X (-Cl, -Br, -I)
Oxygen	1. Alcohol	- O - H	-OH
	2. Aldehyde	$\begin{array}{c} \text{O} \\    \\ -\text{C} - \text{H} \end{array}$	-CHO
	3. Ketone	$\begin{array}{c} \text{O} \\    \\ -\text{C} - \end{array}$	-CO-
	4. Carboxylic Acid	$\begin{array}{c} \text{O} \\    \\ -\text{C} - \text{O} - \text{H} \end{array}$	-COOH
	5. Ether	- O -	-O-
	6. Ester	$\begin{array}{c} \text{O} \\    \\ -\text{C} - \text{O} - \end{array}$	-COO-
Nitrogen	Amines	$\begin{array}{c} -\text{N} - \text{H} \\   \\ \text{H} \end{array}$	- NH <sub>2</sub>

### 9.16 Some functional groups in carbon compounds

#### Homologous series

You have seen that chains of different length are formed by joining the carbon atoms to each other. Moreover you have also seen that a functional group can take place of a hydrogen atom on these chains. As a result of this, large number of compounds are formed having the same functional groups but different length of carbon chain. For example, there are many compounds such as CH<sub>3</sub>-OH, CH<sub>3</sub>-CH<sub>2</sub>-OH, CH<sub>3</sub>-CH<sub>2</sub>-CH<sub>2</sub>-OH, CH<sub>3</sub>-CH<sub>2</sub>-CH<sub>2</sub>-CH<sub>2</sub>-OH which contain alcohol as the functional group. Though the length of the carbon chains in them is different, their chemical properties are very much similar due to the presence of the same functional group in them. The series of compounds formed by joining the same functional group in the place of a particular hydrogen atom on the chains having sequentially increasing length is called homologous series. There are different homologous series in accordance with the functional group. For example, homologous series of alcohols, homologous series of carboxylic acids, homologous series of aldehydes, etc. All the members of the homologous series are homologues of each other. Earlier you filled the structural formulae and molecular formulae in the table 9.12. From that the initial part of the homologous series of alkanes was formed.

Let us understand the characteristics of homologous series by considering initial parts of homologous series of alkanes, alkenes and alcohols. (See table No. 9.17.)



#### Complete the table

Fill in the gaps in the table 9.17 a, b and c of homologous series.

### a. Homologous Series of Alkanes

Name	Molecular formula	Condensed Structural formula	Number of carbon atoms	Number of -CH <sub>2</sub> - units	Boiling point °C
Methane	CH <sub>4</sub>	CH <sub>4</sub>	1	1	- 162
Ethane	C <sub>2</sub> H <sub>6</sub>	CH <sub>3</sub> -CH <sub>3</sub>	2	2	- 88.5
Propane	C <sub>3</sub> H <sub>8</sub>	CH <sub>3</sub> -CH <sub>2</sub> -CH <sub>3</sub>	3	3	- 42
Butane	C <sub>4</sub> H <sub>10</sub>	CH <sub>3</sub> -CH <sub>2</sub> -CH <sub>2</sub> -CH <sub>3</sub>	...	...	0
Pentane	C <sub>5</sub> H <sub>12</sub>	CH <sub>3</sub> -CH <sub>2</sub> -CH <sub>2</sub> -CH <sub>2</sub> -CH <sub>3</sub>	...	...	36
Hexane	C <sub>6</sub> H <sub>14</sub>	CH <sub>3</sub> -CH <sub>2</sub> -CH <sub>2</sub> -CH <sub>2</sub> -CH <sub>2</sub> -CH <sub>3</sub>	...	...	69

### b. Homologous Series of Alcohols

Name	Molecular formula	Condensed Structural formula	Number of carbon atoms	Number of -CH <sub>2</sub> - units	Boiling point °C
Methanol	CH <sub>4</sub> O	CH <sub>3</sub> -OH	1	1	63
Ethanol	C <sub>2</sub> H <sub>6</sub> O	CH <sub>3</sub> -CH <sub>2</sub> -OH	2	2	78
Propanol	C <sub>3</sub> H <sub>8</sub> O	CH <sub>3</sub> -CH <sub>2</sub> -CH <sub>2</sub> -OH	...	...	97
Butanol	C <sub>4</sub> H <sub>10</sub> O	CH <sub>3</sub> -CH <sub>2</sub> -CH <sub>2</sub> -CH <sub>2</sub> -OH	...	...	118

### c. Homologous Series of Alkenes

Name	Molecular formula	Condensed Structural formula	Number of carbon atoms	Number of -CH <sub>2</sub> - units	Boiling point °C
Ethene	C <sub>2</sub> H <sub>4</sub>	CH <sub>2</sub> =CH <sub>2</sub>	2	0	- 102
Propene	C <sub>3</sub> H <sub>6</sub>	CH <sub>3</sub> -CH=CH <sub>2</sub>	3	1	- 48
1-Butene	C <sub>4</sub> H <sub>8</sub>	CH <sub>3</sub> -CH <sub>2</sub> -CH=CH <sub>2</sub>	...	...	- 6.5
1-Pentene	C <sub>5</sub> H <sub>10</sub>	CH <sub>3</sub> -CH <sub>2</sub> -CH <sub>2</sub> -CH=CH <sub>2</sub>	...	...	30

## 9.17 Some Homologous Series



**Use your brain power !**

1. By how many -CH<sub>2</sub>- (methylene) units do the formulae of the first two members of homologous series of alkanes, methane (CH<sub>4</sub>) and ethane (C<sub>2</sub>H<sub>6</sub>) differ? Similarly, by how many -CH<sub>2</sub>- units do the neighbouring members ethane (C<sub>2</sub>H<sub>6</sub>) and propane (C<sub>3</sub>H<sub>8</sub>) differ from each other?
2. How many methylene units are extra in the formula of the fourth member than the third member of the homologous series of alcohols?
3. How many methylene units are less in the formula of the second member than the third member of the homologous series of alkenes?

You have found that in any homologous series while going in an increasing order of the length of the carbon chain, every time one methylene unit ( $-\text{CH}_2-$ ) goes on increasing. Therefore, while going in an increasing order of the length there is a rise in the molecular mass of the members by 14 u.

Inspection of the table 9.17 (a), (b) and (c) will reveal one more point to you, and that is gradation in the boiling points. Boiling point is a physical property of a compound. Generally it is found that, while going in an increasing order in any homologous series the physical properties show variation in one direction, that is, a gradation is observed in the physical properties.



**Use your brain power !**

1. The table 9.17 (c) shows the homologous series of alkenes. Inspect the molecular formulae of the members of this series. Do you find any relationship, in the number of carbon atoms and the number of hydrogen atoms in the molecular formulae?
2. If the number of carbon atoms in the molecular formulae of alkenes is denoted by 'n', what will be the number of hydrogen atoms?

The molecular formulae of the members of the homologous series of alkenes can be represented by a general formula  $\text{C}_n\text{H}_{2n}$ . When the value of 'n' is '2'. We get the molecular formula of the first member of this series as  $\text{C}_2\text{H}_{2 \times 2}$ , that is,  $\text{C}_2\text{H}_4$ . When the value of 'n' is '3', the molecular formula of the second member of the alkene series is obtained as  $\text{C}_3\text{H}_{2 \times 3}$ , that is,  $\text{C}_3\text{H}_6$ .

1. What would be the general formula for the molecular formulae of the members of the homologous series of alkanes? What would be the value of 'n' for the first member of this series?

2. The general molecular formula for the homologous series of alkynes is  $\text{C}_n\text{H}_{2n-2}$ . Write down the individual molecular formulae of the first, second and third members by substituting the values 2,3 and 4 respectively for 'n' in this formula. From the above examples we come to know the following characteristics of the homologous series.

- (i) While going from one member to the next in a homologous series.
  - (a) One methylene ( $-\text{CH}_2-$ ) unit gets added.
  - (b) molecular mass increases by 14 u.
  - (c) number of carbon atoms increases by one.
- (ii) Chemical properties of members of a homologous series show similarity.
- (iii) All the members of a homologous series can be represented by The same a general molecular formula.



**Use your brain power !**

1. Write down structural formulae of the first four members of the various homologous series formed by making use of the functional groups in the table 9.16
2. General formula of the homologous series of alkanes is  $\text{C}_n\text{H}_{2n+2}$ . Write down the molecular formula of the 8<sup>th</sup> and 12<sup>th</sup> member using this.

## Nomenclature systems of carbon compounds

**a. System of common names :** We have seen that today millions of carbon compounds are known. Initially when the number of known carbon compounds was small, scientists named them in a variety of ways. Now those names are called common names. For example, the sources of the names of the first four alkanes, namely methane, ethane, propane and butane are different. The names of the alkanes thereafter were given from number of carbon atoms in them. Two isomeric compounds having a straight chain or branched chain in their structural formulae are possible for the molecular formula  $\text{C}_4\text{H}_{10}$ . the difference and interrelationship in them was indicated by naming them as n-butane (normal-butane) and i-butane (iso-butane).





**Use your brain power !**

1. Draw three structural formulae having molecular formula  $C_5H_{12}$ .
2. Give the names n-pentane, 1(i-pentane) and neo-pentane to the above three structural formulae. (Use the same logic as used in the names of the isomeric butanes for this purpose.)
3. Draw all the possible structural formulae having molecular formula  $C_6H_{14}$ . Give names to all the isomers. Which difficulties were faced by you while naming?  
As the time progressed, the carbon compounds became very large in number and their common names caused confusion. A need was felt to have a logical system acceptable to all for naming the carbon compounds.

### IUPAC nomenclature system

International Union for Pure and Applied Chemistry (IUPAC) put forth a nomenclature system based on the structure of the compounds, and it was accepted all over the world. There is a provision in this system for giving a unique name to all the carbon compounds. Let us see how some straight chain compounds containing one functional group are given IUPAC names and let us also see their common names.

There are three units in the IUPAC name of any carbon compound : parent, suffix and prefix. These are arranged in the name as follows

**prefix - parent - suffix**

An IUPAC name is given to a compound on the basis of the name of its parent alkane. The name of the compound is constructed by attaching appropriate suffix and prefix to the name of the parent alkane. The steps in the IUPAC nomenclature of straight chain compounds are as follows.

**Step 1 :** Draw the structural formula of the straight chain compound and count the number of carbon atoms in it. The alkane with the same number of carbon atoms is the parent alkane of the concerned compound. Write the name of this alkane. In case the carbon chain of the concerned compound contains a double bond, change the ending of the parent name from 'ane' to 'ene'. If the carbon chain in the concerned compound contains a triple bond, change the ending of the parent name from 'ane' to 'yne'. (See the table 9.18)

Sr.No.	Structural formula	Straight chain	Parent name
1	$CH_3-CH_2-CH_3$	C-C-C	propane
2	$CH_3-CH_2-OH$	C-C	ethane
3	$CH_3-CH_2-COOH$	C-C-C	propane
4	$CH_3-CH_2-CH_2-CHO$	C-C-C-C	butane
5	$CH_3-CH=CH_2$	C-C=C	propene
6	$CH_3-C \equiv CH$	C-C $\equiv$ C	propyne

### 9.18 IUPAC Nomenclature of straight chain compounds: step 1

**Step 2:** If the structural formula contains a functional group replace the last letter 'e' from the parent name by the condensed name of the functional group as the suffix. (Exception : The condensed name of the functional group 'halogen' is always attached as the prefix.) (see the table 9.19)

**Step 3:** Number the carbon atoms in the carbon chain from one end to the other. Assign the number '1' to carbon in the functional group -CHO or -COOH, if present, Otherwise, the chain can be numbered in two directions. Accept that numbering which gives smaller number to the carbon carrying the functional group. In the final name a digit (number) and a character (letter) should be separated by a small horizontal line (See the table 9.20) (Usually numbering is not required if the carbon chain contain only two carbon atoms)

Sr. No	Structural formula	Functional group (Condensed name)	Parent name	parent-suffix	prefix-parent
1	CH <sub>2</sub> -CH <sub>2</sub> -OH	- OH (ol)	ethane	ethanol	-
2	CH <sub>3</sub> -CH <sub>2</sub> -Cl	- Cl (chloro)	ethane	-	chloroethane
3	Br-CH <sub>2</sub> -CH <sub>3</sub>	-Br (bromo)	ethane	-	bromoethane
4	CH <sub>3</sub> -CH <sub>2</sub> -CHO	- CHO (al)	propane	propanal	-
5	CH <sub>3</sub> -COOH	- COOH (oic acid)	ethane	ethanoic acid	-
6	CH <sub>3</sub> -NH <sub>2</sub>	- NH <sub>2</sub> (amine)	methane	methanamine	-
7	CH <sub>3</sub> -CO-CH <sub>3</sub>	- CO- (one)	propane	propanone	-

### 9.19 IUPAC Nomenclature : Step- 2

Sr. No	Structural formula	Two numberings of the carbon chain	Acceptable numbering	IUPAC name of the compound
1.	$\begin{array}{c} \text{CH}_3-\text{CH}-\text{CH}_3 \\   \\ \text{OH} \end{array}$	$\begin{array}{c} \text{C}^1-\text{C}^2-\text{C}^3 \\   \\ \text{OH} \\ \text{C}^3-\text{C}^2-\text{C}^1 \\   \\ \text{OH} \end{array}$	Both the numberings equivalent	propan-2-ol
2.	$\begin{array}{c} \text{CH}_3-\text{CH}_2-\text{CH}_2-\text{CH}-\text{CH}_3 \\   \\ \text{Cl} \end{array}$	$\begin{array}{c} \text{C}^1-\text{C}^2-\text{C}^3-\text{C}^4-\text{C}^5 \\   \\ \text{Cl} \\ \text{C}^5-\text{C}^4-\text{C}^3-\text{C}^2-\text{C}^1 \\   \\ \text{Cl} \end{array}$	$\text{C}^5-\text{C}^4-\text{C}^3-\text{C}^2-\text{C}^1 \\   \\ \text{Cl}$	2 - chloropentane
3.	$\begin{array}{c} \text{O} \\    \\ \text{CH}_3-\text{C}-\text{CH}_2-\text{CH}_2-\text{CH}_3 \end{array}$	$\begin{array}{c} \text{O} \\    \\ \text{C}_1-\text{C}_2-\text{C}_3-\text{C}_4-\text{C}_5 \\ \text{O} \\    \\ \text{C}_5-\text{C}_4-\text{C}_3-\text{C}_2-\text{C}_1 \end{array}$	$\begin{array}{c} \text{O} \\    \\ \text{C}_1-\text{C}_2-\text{C}_3-\text{C}_4-\text{C}_5 \end{array}$	pentan-2-one

### 9.20 IUPAC Nomenclature : Step- 3

Some more steps are required for writing IUPAC names of compounds having more complex structural units such as branched chains, carbon rings, heterocycles, etc. Study of these will be included in the further standards. At the same time, also keep in mind that there is a practice of using common names of the carbon compounds which are frequently use in the laboratory.



**Complete the table**

The table 9.19 shows common names and structural formulae of a few carbon compounds. Complete the table by writing their IUPAC names in the third column.

Sr. No.	Common name	Structural formula	IUPAC Name
1	ethylene	$\text{CH}_2=\text{CH}_2$	
2	acetylene	$\text{HC}\equiv\text{CH}$	
3	acetic acid	$\text{CH}_3\text{-COOH}$	
4	methyl alcohol	$\text{CH}_3\text{-OH}$	
5	ethyl alcohol	$\text{CH}_3\text{-CH}_2\text{-OH}$	
6	acetaldehyde	$\text{CH}_3\text{-CHO}$	
7	acetone	$\text{CH}_3\text{-CO-CH}_3$	
8	ethyl methyl ketone	$\text{CH}_3\text{-CO-CH}_2\text{-CH}_3$	
9	ethyl amine	$\text{CH}_3\text{-CH}_2\text{-NH}_2$	
10	n-propyl chloride	$\text{CH}_3\text{-CH}_2\text{-CH}_2\text{-Cl}$	

### 9.21 Common and IUPAC names of some carbon compounds

#### Chemical Properties of Carbon Compounds



**Can you recall?**

1. Which is the component of biogas that makes it useful as fuel?
2. Which product is formed by the combustion of elemental carbon?
3. Is the biogas combustion reaction endothermic or exothermic?

**1. Combustion :** Let us first look at combustion as a chemical property of carbon compounds. We have seen in the previous standard that, carbon in the form of various allotropes on ignition in presence of oxygen undergoes combustion to emit heat and light, and forms carbon dioxide. Hydrocarbons as well as most of the carbon compounds undergo combustion in presence of oxygen to emit heat and light and form carbon dioxide and water as the common products. Some of the combustion reactions are as follows.

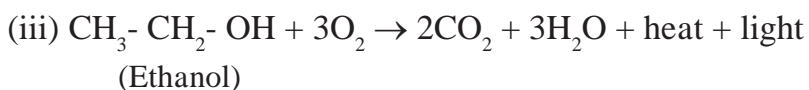
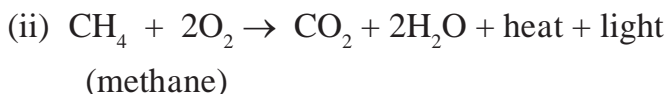
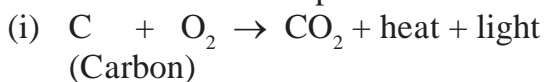

**Use your brain power !**

Propane ( $\text{C}_3\text{H}_8$ ) is one of the combustible component of L.P.G. Write down the reaction for complete combustion of Propane ( $\text{C}_3\text{H}_8$ )



### Try this.

**Apparatus :** Bunsen burner, copper gauze, metal plate, etc.

**Chemicals :** Ethanol, acetic acid, naphthalene

**Procedure :** Place one of the above chemicals (3-4 drops or a pinch) on a clean copper gauze at room temperature, hold it on a blue flame of the Bunsen burner and observe. Is smoke/ soot seen to form due to combustion? Hold the metal plate on the flame when the substance is undergoing combustion. Does any deposit get collected on the plate? Which colour? Repeat the same procedure using other chemicals from the above list.

In the above activity ethanol is a saturated carbon compound, while naphthalene is an unsaturated compound. Generally saturated carbon compounds burn with a clean blue flame while unsaturated carbon compounds burn with a yellow flame and release black smoke. It is this black smoke due to which a deposit of black soot got collected on the metal plate.

Comparison of the molecular formulae indicates that the proportion of carbon is larger in unsaturated compounds than in saturated compounds. As a result, some unburnt carbon particles are also formed during combustion of unsaturated compounds. While in the flame, these hot carbon particles emit yellow light and therefore the flame appears yellow. However, if oxygen supply is limited a yellow flame is obtained by combustion of saturated compounds as well.



### Compare

The proportion of carbon atoms in ethanol ( $C_2H_5OH$ ) and naphthalene ( $C_{10}H_8$ )



### Try this.

Light a Bunsen burner. Open and close the air hole at the bottom of the burner by means of the movable ring around it. When do you get yellow sooty flame? When do you get blue flame?

## 2. Oxidation

You have seen that carbon compounds start burning by combining easily with oxygen in the air when ignited in air. In this process of combustion all the chemical bonds in the molecule of the carbon compound break and  $CO_2$  and  $H_2O$  are formed as the products. In other words the carbon compound is completely oxidised during combustion. Chemical compounds can also be used as source of oxygen. Substances that can give oxygen to other substances are called oxidants or oxidizing agents. Potassium permanganate or potassium dichromate are commonly used as oxidizing agents. An oxidising agent affects on certain functional groups in present carbon compounds.



### Always remember

There are inlets for air in the gas or kerosene stove at home. It is because of these air inlets that the gaseous fuel is mixed with sufficient oxygen and a clean blue flame is obtained. In case there is deposition of black soot on the bottom of cooking vessels it is an indication of choking of the air inlets and thereby the wastage of fuel. In such case the air inlets of the stove should be got cleaned.



### Try this.

**Apparatus :** Test tube, Bunsen burner, measuring cylinder, dropper, etc.

**Chemicals :** Ethanol, dilute solution of sodium carbonate, dilute solution of potassium permanganate.

**Procedure :** Take 2-3 ml ethanol in a test tube, add 5 ml sodium carbonate solution to it and warm the mixture by holding the test tube on the burner for a while. Do dropwise addition of a dilute solution of potassium permanganate to this warm mixture with stirring. Does the typical pink colour of potassium permanganate stay as it is on addition ? Does the pink colour stop vanishing and stays on after some time of the addition process?





The unsaturated compound can also undergo addition reaction with hydrogen to form a saturated compound. However, it is necessary to use a catalyst like platinum or nickel for this reaction. We have already seen that catalyst is such a substance due to presence of which rate of reaction changes without causing any disturbance to it.

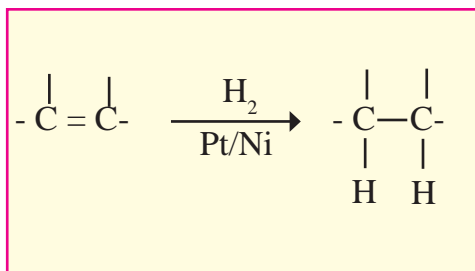

This reaction is used for hydrogenation of vegetable oils in presence of nickel catalyst. You have seen in the above activity that iodine test indicates presence of multiple bonds (double bond in particular) in the molecules of oils while Vanaspati ghee is found to be saturated. The molecules of vegetable oil contain long and unsaturated carbon chains. Hydrogenation transforms them into saturated chains and thereby Vanaspati ghee is formed.

Unsaturated fats containing double bonds are healthy while saturated fats are harmful to health.

#### 4. Substitution reaction

As the single bonds C-H and C-C are very strong, the saturated hydrocarbons are not reactive, and therefore they remain inert in presence of most reagents. However, saturated hydrocarbons, in presence of sunlight react rapidly with chlorine. In this reaction chlorine atoms replace, one by one, all the hydrogen atoms in the saturated hydrocarbon. The reaction in which the place of one type of atom / group in a reactant is taken by another atom / group of atoms, is called substitution reaction. Chlorination of methane, is a substitution reaction which gives four products.



**Still larger number of products are formed in chlorination reaction of higher homologues of alkanes.**



**Use your brain power !**

In the chlorination, substitution reaction of propane two isomeric products containing one chlorine atom are obtained. Draw their structural formulae and give their IUPAC names.

You have learnt about four types of common reactions in the previous chapter. In which of these four types the addition and substitution reaction of carbon compounds can be included? What are the additional details and difference in the addition and substitution reaction?

## Important carbon compounds : Ethanol and Ethanoic Acid

Ethanol and ethanoic acid are two of the commercially important carbon compounds. Let us now learn more about them.

At room temperature colourless ethanol is a liquid and its boiling point is  $78^{\circ}\text{C}$ . Generally ethanol is called alcohol or spirit. Ethanol is soluble in water in all proportions. When aqueous solution of ethanol is tested with litmus paper it is found to be neutral. Consumption of small quantity of dilute ethanol shows its effect, even though it is condemned still it has remained socially widespread practice. Consumption of alcohol harms health in a number of ways. It adversely affects the physiological processes and the central nervous system. Consumption of even a small quantity of pure ethanol (called absolute alcohol) can be lethal. Ethanol being good solvent, it is used in medicines such as tincture iodine (solution of iodine and ethanol), cough mixture and also in many tonics.



### Do you know ?

Methanol ( $\text{CH}_3\text{OH}$ ), the lower homologue of ethanol, is poisonous, and intake of its small quantity can affect vision and at times can be lethal. To prevent the misuse of the important commercial solvent ethanol, it is mixed with the poisonous methanol. Such ethanol is called denatured spirit. A blue dye is also added to it, so that it is easily recognised.

### Chemical properties of ethanol

You have learnt about the oxidation reaction of ethanol in a previous unit of this chapter. Two more reactions of ethanol are as follows. The functional group  $-\text{OH}$  plays an important role in the reactions of ethanol.

#### (i) Reaction with sodium

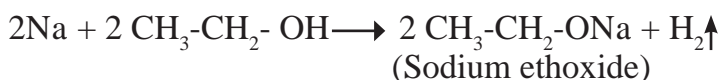

All the alcohols react with sodium metal to liberate hydrogen gas and form sodium alkoxide salts. In the reaction of ethanol with sodium metal, hydrogen gas and sodium ethoxide are formed as products.



### Try this.

**Note :** This activity should be demonstrated by the teacher.

**Apparatus :** Big test tube, delivery tube fitted in a rubber cork, knife, candle, etc.

**Chemicals :** Sodium metal, ethanol, magnesium ribbon, etc.

**Procedure :** Take 10 ml ethanol in a big test tube. Cut sodium metal into 2-3 pieces of a cereal grain size. Put the sodium pieces into the ethanol in the test tube and fix the gas delivery tube to the test tube. Take a burning candle near the outlet of the gas delivery tube and observe.

1. Which is the combustible gas coming out of the gas delivery tube?
2. Why do the sodium pieces appear to dance on the surface of ethanol?
3. Repeat the above procedure using magnesium ribbon instead of sodium.
4. Do you see gas bubble released from the piece of magnesium ribbon?
5. Does magnesium metal react with ethanol?

In previous standard you have learnt that a moderately reactive metal such as magnesium reacts with strong acid to liberate hydrogen gas. Though ethanol is neutral, it reacts with sodium metal and liberates hydrogen gas. Sodium being highly reactive metal, it reacts with the neutral functional group -OH of ethanol.

**(ii) Dehydration reaction :** When ethanol is heated at the temperature 170 °C with excess amount of concentrated sulphuric acid, one molecule of water is removed from its molecule to form ethene, an unsaturated compound.

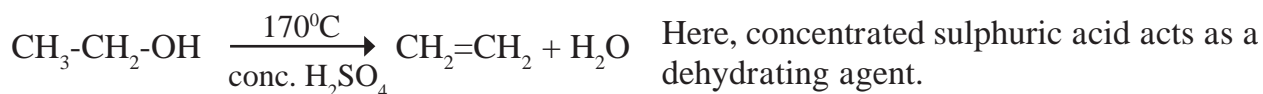

**Use your brain power !**

1. Explain by writing a reaction, what will happen when pieces of sodium metal are put in n- propyl alcohol.
2. Explain by writing a reaction, which product will be formed on heating n - butyl alcohol with concentrated sulphuric acid.

### Science box : Alcohol : A fuel

The sugarcane plant transforms solar energy into chemical energy very efficiently. When molasses, obtained during production of sugar from sugarcane, is subjected to fermentation, alcohol (ethanol) is obtained. On combustion in sufficient air ethanol gives carbon dioxide and water as the only products. In this way, ethanol is a clean fuel. Therefore in some countries it is used as an additive to increase the efficiency of petrol. Such a fuel is called gasohol.

**Ethanoic acid:** Ethanoic acid is a colourless liquid with boiling point 118°C. Ethanoic acid is commonly known as acetic acid. Its aqueous solution is acidic and turns blue litmus red. Vinegar, which is used as preservative in pickles, is a 5-8 % aqueous solution of acetic acid. The melting point of pure ethanoic acid is 17°C. As a result during winter in cold countries ethanoic acid freezes at room temperature itself and looks like ice. Therefore it is named ‘glacial acetic acid’.



**Try this.**

**Apparatus:** Glazed tile, glass rods, pH paper, blue litmus paper.  
**Chemicals :** Dilute ethanoic acid, dilute hydrochloric acid

**Procedure:** Place two strips of blue litmus paper on a glazed tile. Put one drop of dilute hydrochloric acid on one strip with the help of a glass rod. Put one drop dilute ethanoic acid with the help of another glass rod on the other strip. Note the colour change taken place in the litmus strip. Repeat the same procedure using strips of pH paper. Note all the observation in the following table.

Substance	Colour change in blue litmus paper	Corresponding pH (Scratch the unwanted)	Colour change seen on the pH paper	Corresponding pH
Ethanoic acid		< 7 / 7 / > 7		
Hydrochloric acid		< 7 / 7 / > 7		

### 9.23 Testing ethanoic acid & Hydrochloric acid





Use your brain power !

1. Which one of ethanoic acid and hydrochloric acid is stronger?
2. Which indicator paper out of blue litmus paper and pH paper is useful to distinguish between ethanoic acid and hydrochloric acid?

### Chemical Properties of ethanoic Acid

Ethanoic acid contain carboxylic acid as its functional group. The chemical reaction of ethanoic acid are mainly due to this functional group.

#### i. Reaction with base

a. A reaction with strong base

Ethanoic acid gives neutralization reaction with a strong base sodium hydroxide to form a salt and water.

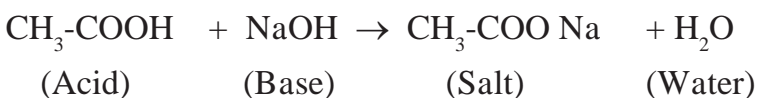

The IUPAC name of the salt formed here is sodium ethanoate while its common name is sodium acetate. You have learnt in the previous standard that acetic acid is a weak acid. Will the salt sodium acetate be neutral?

b. Reaction with carbonate and bicarbonate



Try this.

**Apparatus :** Big test tube, small test tube, bent gas delivery tube, rubber cork, thistle funnel, stand, etc.

**Chemicals :** Acetic acid , sodium carbonate powder, freshly prepared lime water.

**Procedure :** Arrange the apparatus as shown in figure. Place sodium carbonate powder in the big test tube. Pour 10 ml acetic acid through the thistle funnel. Observe the changes taking place in the two test tubes.

1. Which gas does come out as effervescence in the big test tube?
2. Why are bubbles seen in the small test tube ?
3. What is the colour change in the lime water? Write the related equation.

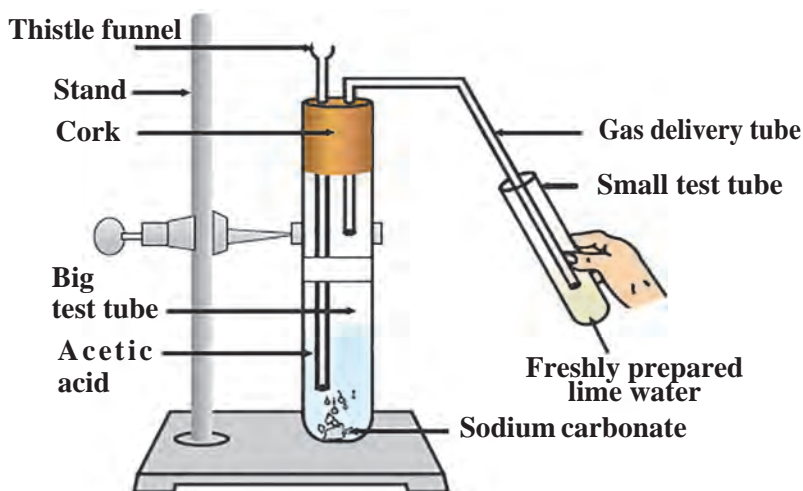

### 9.24 Reaction of acetic acid and sodium carbonate

In this activity ethanoic acid reacts with the basic salt, namely, sodium carbonate, to form a salt, named sodium ethanoate, water and carbon dioxide gas.



The  $\text{CO}_2$  gas of the effervescence passes through the gas delivery tube and reacts with the lime water in the small test tube. 'Lime water turning milky' is the test of carbon dioxide gas. If sodium bicarbonate is used instead of sodium carbonate in the above activity, similar observations are obtained.

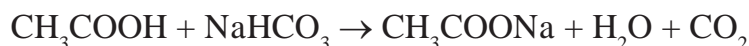

**Use your brain power !**

1. Explain with reaction why does the lime water turn milky in the above activity.
2. Explain the reaction that would take place when a piece of sodium metal is dropped in ethanoic acid.
3. Two test tubes contain two colourless liquids ethanol and ethanoic acid. Explain by writing reaction which chemical test you would perform to tell which substance is present in which test tube.

**ii. Esterification Reaction :** Substances having ester as the functional group are formed by reaction between a carboxylic acid and an alcohol.



**Try this.**

**Apparatus :** Test tube, beakers, burner etc.

**Chemicals :** Glacial ethanoic acid, ethanol concentrated sulphuric acid etc.

**Procedure :** Take 1 ml ethanol and 1 ml glacial ethanoic acid in a test tube. Add a few drops of concentrated sulphuric acid in it. Keep this test tube in the beaker containing hot water (hot water bath) for five minutes. Then take 20-30 ml water in another beaker and pour the above reaction mixture in it and smell it.

Ethanoic acid reacts with ethanol in presence of an acid catalyst and ester, ethyl ethanoate is formed.

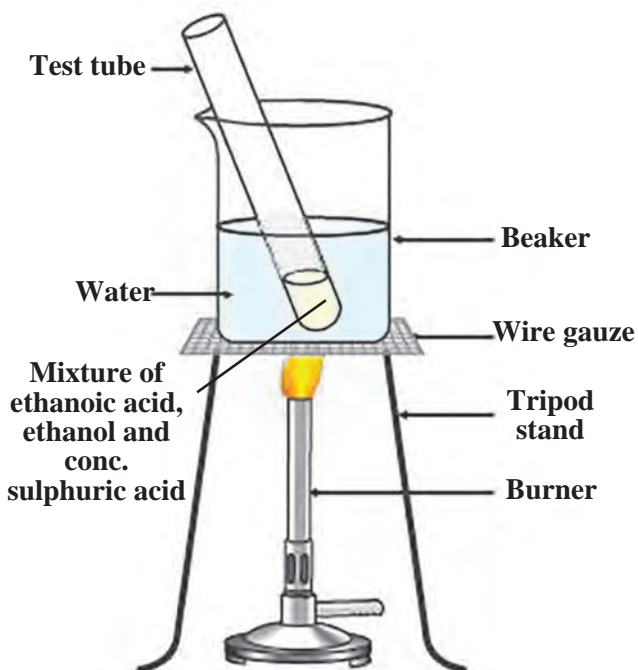

**9.25 Esterification Reaction**

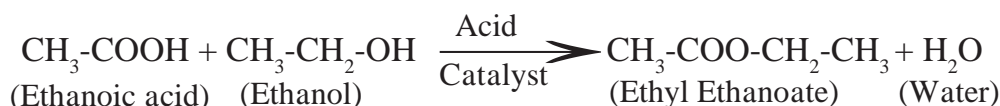

Esters have sweet odour. Majority of fruits owe their odour to a particular ester present in them. Esters are used for making fragrances and flavouring agents. When an ester is reacted with the alkali sodium hydroxide, the corresponding alcohol and carboxylic acid (in the form of its sodium salt) are obtained back. This reaction is called saponification reaction, as it is used for preparation of soap from fats.



**Use your brain power !**

When fat is heated with sodium hydroxide solution, soap and glycerin are formed. Which functional groups might be present in fat and glycerin? What do you think?

### Macro molecules and Polymers



**Can you tell?**

1. What are the chemical names of the nutrients that we get from the food stuffs namely cereals, pulses and meat?
2. What are the chemical substances that make cloth, furniture and elastic objects?

**Macromolecules** : We have seen in the beginning of this chapter that the number of the known carbon compounds is as large as about 10 million, and the range of their molecular masses is as large as  $10^1$ -  $10^{12}$ . The number of constituent atoms is very large for the molecules with high molecular mass. The giant carbon molecules formed from hundreds of thousands of atoms are called macromolecules. They are from the type of compounds called polymers.

**Natural macromolecules** : The natural macromolecules namely, polysaccharides, proteins and nucleic acids are the supporting pillars of the living world. We get food, clothing and shelter from polysaccharides, namely, starch and cellulose. Proteins constitute a large part of the bodies of animals and also are responsible for their movement and various physiological processes. Nucleic acids control the heredity at molecular level. Rubber is another type of natural macromolecule.

**Manmade macromolecules** : Macromolecules were produced for the first time in the laboratory and factory with an intention to invent an alternative for rubber and silk. Today manmade macromolecules are in use in every walk of life. Manmade fibres which have strength along the length similar to natural fibres cotton, wool and silk; elastomers which have the elastic property of rubber; plastics from which innumerable types of articles, sheets, pipes and surface coatings are made are all examples of manmade macromolecules. The structure of natural and manmade macromolecules is formed by joining several small units in a regular manner. As a result the macromolecules are polymeric in nature.

**Polymers** : A macromolecule formed by regular repetition of a small unit is called polymer. The small unit that repeats regularly to form a polymer is called monomer. The reaction by which monomer molecules are converted into a polymer is called polymerization.

One important method of polymerization is to make a polymer by joining alkene type monomers. For example, synthesis of polyethylene is as shown further (see 9.26). Also, the table 9.27 shows the polymers used in large scale.

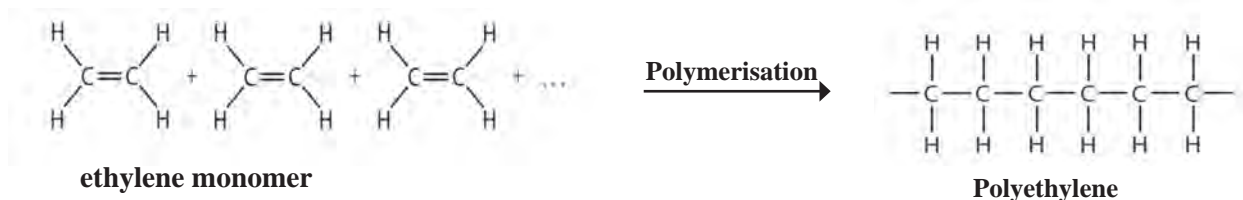

### 9.26 Synthesis of polyethylene

Name of polymer	Constituent monomer	Structural formula of the polymer	Uses
Polyethylene	Ethylene $\text{CH}_2 = \text{CH}_2$	$\left( \begin{array}{cc} \text{H} & \text{H} \\   &   \\ -\text{C} & - & \text{C}- \\   &   \\ \text{H} & \text{H} \end{array} \right)_n$	Carry bags, sports wear
Polystyrene	Styrene $\text{C}_6\text{H}_5 - \text{CH} = \text{CH}_2$	$\left[ \begin{array}{c} \text{C}_6\text{H}_5 \\   \\ -\text{C} - \text{CH}_2- \\   \\ \text{H} \end{array} \right]_n$	Thermocol articles
Polyvinyl chloride (PVC)	Vinyl chloride $\text{Cl} - \text{CH} = \text{CH}_2$	$\left[ \begin{array}{cc} \text{H} & \text{H} \\   &   \\ -\text{C} & - & \text{C}- \\   &   \\ \text{H} & \text{Cl} \end{array} \right]_n$	P.V.C. pipes, door mats, tubes and bags in hospital kits.
Polyacrylo nitrile	Acrylo nitrile $\text{CH}_2 = \text{CH} - \text{C} \equiv \text{N}$	$\left[ \text{CH}_2 - \underset{\text{C} \equiv \text{N}}{\text{CH}} \right]_n$	Winter clothing, blankets
Teflon	Tetrafluoro ethylene $\text{CF}_2 = \text{CF}_2$	$\left[ \begin{array}{cc} \text{F} & \text{F} \\   &   \\ -\text{C} & - & \text{C}- \\   &   \\ \text{F} & \text{F} \end{array} \right]_n$	Nonstick cookware
Polypropylene	Propylene $\text{CH}_3 - \text{CH} = \text{CH}_2$	$\left[ \begin{array}{c} \text{CH}_3 \\   \\ -\text{CH} - \text{CH}_2- \\   \\ \text{H} \end{array} \right]_n$	Injection syringe, Furniture

### 9.27 Various polymers and their uses

The polymers in the above examples are formed by repetition of single monomer. These are called homopolymers. The other type of polymers are formed from two or more monomers. They are called copolymers. For example, PET is poly ethylene terephthalate. The structures of polymers are linear as in the above examples or they are branched and cross linked as well. Polymers acquire various properties as per the nature of the monomers and the type of structure.

The composition and structure of natural polymers were understood after carrying out their decomposition. The composition of the main natural polymer is given in the Table 9.28.



Polymer	Name of the monomer	Occurrence
Polysaccharide	Glucose	Starch
Cellulose	Glucose	Wood (cell walls of plant cells)
Proteins	$\alpha$ amino acids	Muscles, hair, enzymes, skin, egg
D.N.A.	Nucleotide (deoxyribose-phosphate)	Chromosomes of organisms
R.N.A.	Nucleotide (ribose-phosphate)	Nucleus and cytoplasm of cell
Rubber	Isoprene $\text{CH}_2 = \underset{\text{CH}_3}{\text{C}} - \text{CH} = \text{CH}_2$	Latex of rubber tree



**Use your brain power !**

1. Structural formulae of some monomers are given below. Write the structural formula of the homopolymer formed from them.

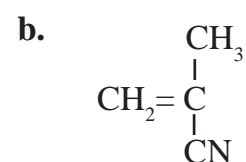
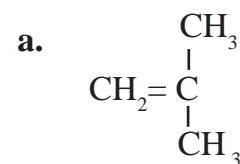

### 9.28 Some natural polymers and their occurrence

2. From the given structural formula of polyvinyl acetate, that is used in paints and glues, deduce the name and structural formula of the corresponding monomer.

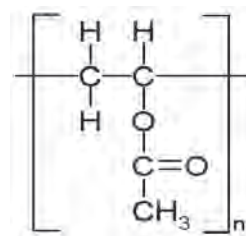

### Exercise



1. Match the pairs.

Group 'A'

Group 'B'



1. Unsaturated hydrocarbon



2. Molecular formula of an alcohol



3. Saturated hydrocarbon



4. Triple bond

2. Draw an electron dot structure of the following molecules. (Without showing the circles)

a. Methane

b. Ethene

c. Methanol

d. Water

3. Draw all possible structural formulae of compounds from their molecular formula given below.



4. Explain the following terms with example.

- Structural isomerism
- Covalent bond
- Hetero atom in a carbon compound
- Functional group
- Alkane
- Unsaturated hydrocarbon
- Homopolymer
- Monomer
- Reduction
- Oxidant

**5. Write the IUPAC names of the following structural formulae.**

- a.  $\text{CH}_3\text{-CH}_2\text{-CH}_2\text{-CH}_3$                       b.  $\text{CH}_3\text{-CHOH-CH}_3$   
c.  $\text{CH}_3\text{-CH}_2\text{-COOH}$                       d.  $\text{CH}_3\text{-CH}_2\text{-NH}_2$   
e.  $\text{CH}_3\text{-CHO}$                                   f.  $\text{CH}_3\text{-CO-CH}_2\text{-CH}_3$

**6. Identify the type of the following reaction of carbon compounds.**

- a.  $\text{CH}_3\text{-CH}_2\text{-CH}_2\text{-OH} \longrightarrow \text{CH}_3\text{-CH}_2\text{-COOH}$   
b.  $\text{CH}_3\text{-CH}_2\text{-CH}_3 \longrightarrow 3 \text{CO}_2 + 4 \text{H}_2\text{O}$   
c.  $\text{CH}_3\text{-CH=CH-CH}_3 + \text{Br}_2 \longrightarrow \text{CH}_3\text{-CHBr-CHBr-CH}_3$   
d.  $\text{CH}_3\text{-CH}_3 + \text{Cl}_2 \longrightarrow \text{CH}_3\text{-CH}_2\text{-Cl} + \text{HCl}$   
e.  $\text{CH}_3\text{-CH}_2\text{-CH}_2\text{-CH}_2\text{-OH} \longrightarrow \text{CH}_3\text{-CH}_2\text{-CH=CH}_2 + \text{H}_2\text{O}$   
f.  $\text{CH}_3\text{-CH}_2\text{-COOH} + \text{NaOH} \longrightarrow \text{CH}_3\text{-CH}_2\text{-COO}^-\text{Na}^+ + \text{H}_2\text{O}$   
g.  $\text{CH}_3\text{-COOH} + \text{CH}_3\text{-OH} \longrightarrow \text{CH}_3\text{-COO-CH}_3 + \text{H}_2\text{O}$

**7. Write structural formulae for the following IUPAC names.**

- a. pentan -2-one                              b. 2- chlorobutane  
c. propan - 2- ol                              d. methanal  
e. butanoic acid                                f. 1- bromopropane  
g. ethanamine                                  h. butanone

**8. Write answers as directed.**

- a. What causes the existence of very large number of carbon compound ?  
b. Saturated hydrocarbons are classified into three types. Write these names giving one example each.  
c. Give any four functional groups containing oxygen as the heteroatom in it. Write name and structural formula of one example each.  
d. Give names of three functional groups containing three different hetero atoms. Write name and structural formula of one example each.  
e. Give names of three natural polymers. Write the place of their occurrence and names of monomers from which they are formed.  
f. What is meant by vinegar and gasohol? What are their uses ?  
g. What is a catalyst ? Write any one reaction which is brought about by use of catalyst ?

**Project**

Prepare a chart giving detailed information of carbon compounds in everyday use. Display it in the class and discuss.



## 10. Space Missions



- Space Missions
- Classification of artificial satellites
- Satellite launch vehicles
- Artificial satellites
- Orbits of artificial satellites
- Space missions away from the Earth



### Can you recall

1. What is the difference between space and sky?
2. What are different objects in the Solar system?
3. What is meant by a satellite?
4. How many natural satellites does the earth have?

Man has always been curious about unknown places and he has always been eager to expand the horizons of his knowledge by exploring the unknown world. He must have had deep curiosity about the space and the many twinkling stars in the dark sky. He must have had dreams to fly to the space and must have been working for that.

### Space missions

Substantial developments in technology, specially space technology, in the later half of twentieth century resulted in the development of space crafts making space voyage possible. Since then, more than a thousand artificial satellites have been placed into orbits around the earth. Additionally, space missions have been undertaken for close observation of various objects in our solar system. We will learn about all this in this chapter.

We can classify the space missions into two categories. In one type of missions, the objective is to put artificial satellites in orbits around the earth for research and various other useful applications. The objective of second type of missions is to send the spacecrafts to outer space for close observations and understanding of the objects in solar system, or even outside the solar system.



### Do you know ?

The first person to go into the space in a spacecraft was Yuri Gagarin of the then USSR. He orbited the earth in 1961. The first person to step on the Moon (1969) was Neil Armstrong of USA. Rakesh Sharma of India orbited the earth in 1984 in a Russian spacecraft. Kalpana Chawla and Sunita Williams of Indian origin also participated in space explorations through missions organized by NASA (National Aeronautics and Space Administration) of USA.



### Can you recall?

Which types of telescopes are orbiting around the earth? Why it is necessary to put them in space?



### Can you tell?

Where does the signal in your cell phone come from? Where from does it come to mobile towers? Where does the signal to your TV set come from? You may have seen photographs showing the position of monsoon clouds over the country, in the newspaper. How are these images obtained?



**10.1 Communication by artificial satellite**

## Need and importance of space missions:

The world has become a global village due to space missions. Today, we can contact a person in any part of the world within a second. We can gather information about worldwide events sitting at home. You all know the importance of internet. Due to internet, every information is available at our fingertips. It has become possible to get advance alert about natural calamities and take proper precautions.

During war, it is possible to get information about the actions of the enemy through aerial surveillance using satellites. It is also possible to explore the fossil reserves and minerals in the earth. Thus, there are unlimited applications of space missions. Today, space technology is an inevitable part for development of a nation.

### Artificial satellite

A natural satellite is an astronomical object orbiting the earth or any other planet. The moon is the only natural satellite of the earth. Some other planets in the solar system have more than one natural satellites. Similarly if a manmade object revolves around the earth or any other planet in a fixed orbit it is called an artificial satellite (fig 10.1).

The first artificial satellite '*Sputnik*' was sent to space by Soviet Union in 1957(see figure 10.2). Today, more than thousand satellites are orbiting the earth. The satellites work on solar energy. So, solar photovoltaic panels are attached on both sides of these satellites like wings. Instruments are installed in the satellites to receive and transmit signals from and to the earth.

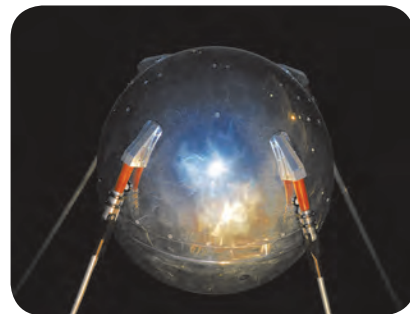

**10.2 Sputnik**

The satellites have various other types of instruments, depending on their functions. One such satellite is shown in figure 10.1. Signals transmitted from the earth to the satellite and from the satellite to a mobile tower and mobile phone are also shown. These satellites are sent into the space to perform various functions. Depending on their functions, satellites are classified into following categories:

#### Use of ICT

Prepare a power point presentation showing India's contribution in space research and present it in the class.

INSAT: Indian National Satellite  
 GSAT: Geosynchronous Satellite  
 IRNSS: Indian Regional Navigation Satellite System  
 IRS : Indian Remote Sensing Satellite  
 GSLV: Geosynchronous Satellite Launch Vehicle  
 PSLV: Polar Satellite Launch Vehicle

Type of satellite	Function of the satellite	The names of Indian satellite series and their launch vehicles
Weather satellite	Study and prediction of weather.	INSAT and GSAT. Launcher: GSLV.
Communication satellite	Establish communication between different location in the world through use of specific waves.	INSAT and GSAT. Launcher: GSLV.
Broadcast satellite	Telecasting of television programs.	INSAT and GSAT. Launcher: GSLV.
Navigational satellite	Fix the location of any place on the earth's surface in terms of its very precise latitude and longitude.	IRNSS. Launcher : PSLV.
Military Satellite	Collect information for security aspects.	
Earth Observation Satellite	Study of forests, deserts, oceans, polar ice on the earth's surface, exploration and management of natural resources, observation and guidance in case of natural calamities like flood and earthquake.	IRS. Launcher : PSLV.

### Types of satellites



Internet is my friend

**Watch and share with others**

1. <https://youtu.be/cuqYLHaLB5M>
2. <https://youtu.be/y37iHU0jK4s>

### Orbits of Artificial Satellites

All artificial satellites do not revolve in similar orbits around the earth. The functions of the satellite decide the height of the satellite's orbit from the earth's surface, the nature of the orbit (circular/elliptical) and whether the orbit shall be parallel to equator or making some angle with it. To put the satellite in its proper orbit at specific height above the earth's surface, the satellite is taken to that height using a satellite launcher. Then the satellite is given a specific velocity known as the critical velocity ( $v_c$ ) in a tangential direction to the orbit (fig 10.3). The satellite then starts revolving around the earth. The formula for the velocity  $v_c$  can be derived as below.

If a satellite of mass 'm' is revolving around the earth in an orbit of height 'h' with speed ' $v_c$ ', then as seen in the chapter on 'Gravitation', a centripetal force  $\frac{mv_c^2}{r}$  will act on it.

Here, 'r' is the orbital radius of the satellite from the centre of the earth.

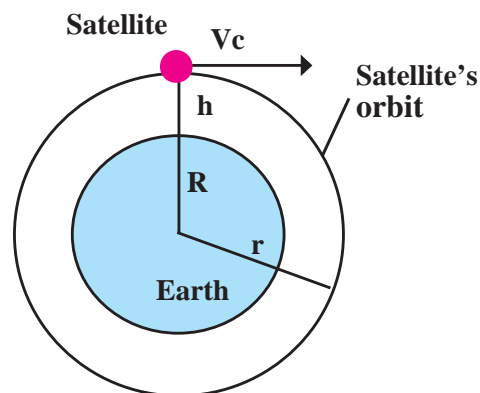

10.3 Orbit of an artificial satellite



This centripetal force is provided by the gravity of the earth.

Therefore, centripetal force = gravitational force between the Earth and the satellite.

$$\frac{mv_c^2}{R+h} = \frac{GMm}{(R+h)^2}$$

$$v_c^2 = \frac{GM}{R+h}$$

$$v_c = \sqrt{\frac{GM}{R+h}} \quad \dots\dots\dots (1)$$

G = Gravitational constant =  $6.67 \times 10^{-11} \text{ N m}^2/\text{kg}^2$

M = Mass of the earth =  $6 \times 10^{24} \text{ kg}$

R = Radius of the earth =  $6.4 \times 10^6 \text{ m} = 6400 \text{ km}$

h = Height of the satellite above earth surface

R + h = Radius of the orbit of satellite.

It can be seen that the critical velocity does not depend on the mass of the satellite. As the height of the satellite's orbit from the earth's surface increases, the critical velocity decreases. Depending on the height of the satellite's orbit above the earth's surface, the satellite orbits are classified as below:

**High Earth Orbits : (Height from the earth's surface > 35780 km)**

If the height of the satellite's orbit above the earth's surface is greater than or equal to 35780 km, the orbit is called High earth Orbit. As we will see in the next solved example, a satellite revolving in an orbit 35780 km above the earth's surface, will take around 24 hours to complete one revolution. We know, that the earth also takes almost 24 hrs for one revolution. If the satellite is revolving in an orbit parallel to the equator, the time of revolution for the earth around itself and that for the satellite to revolve around the earth being the same, the satellite will appear to be stationary with respect to the earth. For a passenger in one vehicle, another vehicle, moving parallel to him with equal velocity, appears to be stationary. This is what happens here also. These satellites are, therefore, called geosynchronous satellites. Since, these satellites are stationary with reference to the earth, they can observe a specific portion of the earth, continuously. Therefore, they are used in applications like meteorology and for carrying signals for telephone, television, radio etc.

**Medium Earth Orbit (height above the earth's surface 2000 km to 35780 km)**

If the height of the satellite orbit above the earth's surface is in between 2000 km and 35780 km, the orbits are called medium earth orbits. The geostationary satellites orbit above the equator. These are, therefore, not useful in the study of polar regions. For this purpose, elliptical medium earth orbits passing over the polar region are used. These orbits are called polar orbits. In these orbits, the satellites complete one revolution in 2 to 24 hours.

Some of these satellites revolve in circular orbits at a height of around 20,200 km above the earth's surface. Global positioning satellites revolve in such orbits.

**Low Earth Orbits (height above the earth's surface: 180 km to 2000 km)**

If the height of the satellite orbit above the earth's surface is in between 180 km and 2000 km, the orbits are called Low earth Orbits. The satellites used for scientific experiments and atmospheric studies revolve in low earth orbits. Depending on the height of their orbits, they complete one revolution in around 90 minutes. International Space Station and Hubble telescope also revolve in Low earth Orbits.

Figure 10.4 shows various orbits of satellites.

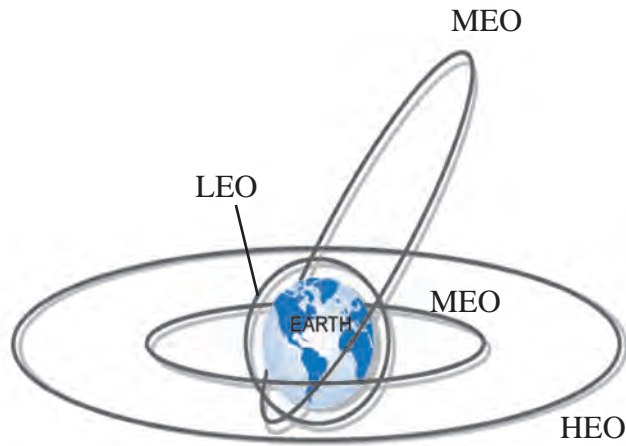

10.4 Orbits of satellites



**Do you know ?**

A group of students from COEP (College of Engineering, Pune) made a small satellite and sent it to the space through ISRO in 2016. The name of the satellite is ‘Swayam’ and it weighs around 1 kg. It is orbiting the earth at a height of 515 km. The main objective of the satellite was to provide point to point messaging services using a special method.

**Solved Example**

**Example 1.** Suppose the orbit of a satellite is exactly 35780 km above the earth’s surface. Determine the tangential velocity of the satellite.

**Given :**  $G = 6.67 \times 10^{-11} \text{ N m}^2/\text{kg}^2$  ,  
 $M = 6 \times 10^{24} \text{ kg}$  (for earth)  
 $R = 6400 \text{ km}$  (for earth) =  $6.4 \times 10^6 \text{ m}$  ,  
 $h =$  height of the satellite above the earth’s surface 35780 km.

$v = ?$

$$R + h = 6400 + 35780 = 42180 \times 10^3 \text{ m}$$

$$v = \sqrt{\frac{GM}{R+h}}$$

$$= \sqrt{\frac{(6.67 \times 10^{-11}) \times (6 \times 10^{24})}{42180 \times 10^3 \text{ m}}}$$

$$= \sqrt{\frac{40.02 \times 10^{13}}{42180 \times 10^3}}$$

$$= \sqrt{\frac{40.02}{42180} \times 10^{10}}$$

$$= \sqrt{0.0009487909 \times 10^{10}}$$

$$= \sqrt{9487909}$$

$$v = 3080.245 \text{ m/s} = 3.08 \text{ km/s}$$

**Example 2.** In the previous example, how much time the satellite will take to complete one revolution around the earth?

**Given:** Height of the satellite above the earth’s surface= 35780 km.

Velocity of the satellite=3.08 km/sec

**Solution:** Suppose, the satellite takes  $T$  seconds to complete one revolution around the earth. The distance travelled during this one revolution is equal to the circumference of the circular orbit. If  $r$  is the radius of the orbit, the satellite will travel a distance  $2\pi r$  during one revolution. Thus, the time required for one complete revolution can be obtained as follows:

$$v = \frac{\text{distance}}{\text{time}} = \frac{\text{circumference}}{\text{time}} = \frac{2 \pi r}{T}$$

$$T = \frac{2 \pi r}{v} = \frac{2 \pi (R+h)}{v}$$

$$= \frac{2 \times 3.14 \times (6400 + 35780)}{3.08}$$

$$= 86003.38 \text{ sec}$$

$$= 23.89 \text{ hrs.} = 23 \text{ hrs } 54 \text{ M.}$$

(Here, since the velocity is taken in the unit of km/s, the radius is also taken in unit of km)

## Satellite Launch Vehicles

Satellite launch vehicles are used, to place the satellites in their specific orbits. The functioning of the satellite launch vehicle is based on the Newton's third law of motion. The launch vehicle uses specific type of fuel. The gas produced due to combustion of the fuel expands due to its high temperature and is expelled forcefully through the nozzles at rear side of the launch vehicle. As a reaction of this, a thrust acts on the vehicle, which drives the vehicle high in to the space.

The structure of the launch vehicle is decided by the weight of the satellite and the type of satellite orbit. The fuel of the vehicle also depends on these factors. The fuel forms a major portion of the total weight of the launch vehicle. Thus, the vehicle has to carry a large weight of the fuel with it. To overcome this problem, launch vehicles with more than one stage are used. Due to this, the weight of the vehicle can be reduced step by step, after its launching. For example, consider a launch vehicle having two stages. For launching the vehicle, the fuel and

engine in the first stage are used. This imparts a specific velocity to the vehicle and takes it to a certain height. Once the fuel in this first stage is exhausted, the empty fuel tank and the engine are detached from the main body of the vehicle and fall either into a sea or on an unpopulated land. As the fuel in the first stage is exhausted, the fuel in the second stage is ignited. However, the vehicle now contains only one (i.e. the second) stage. The weight now being reduced, the vehicle can move with higher speed. Almost all vehicles are made of either two or more stages. As an example, the structure of a Polar Satellite Launch Vehicle (PSLV) developed by ISRO of India is shown in fig 10.5a.

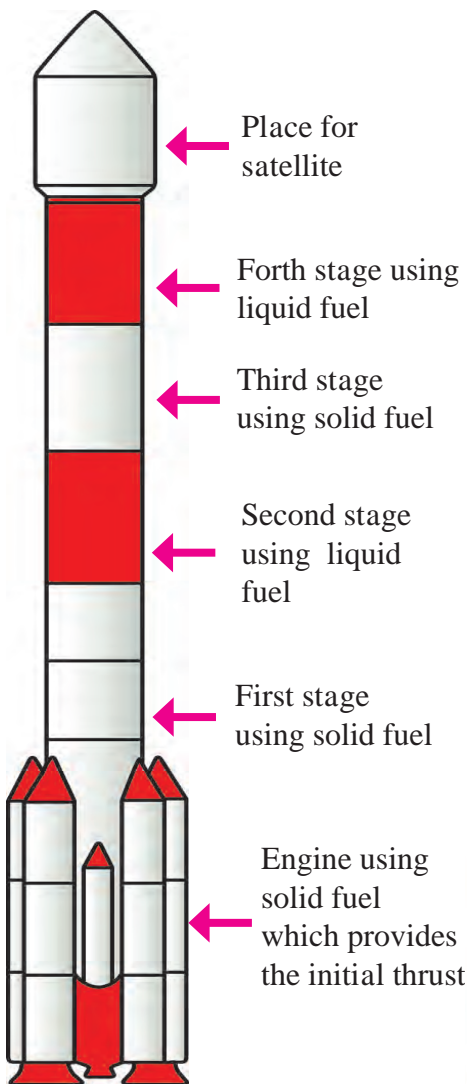

**10.5 a. Structure of PSLV made by ISRO**

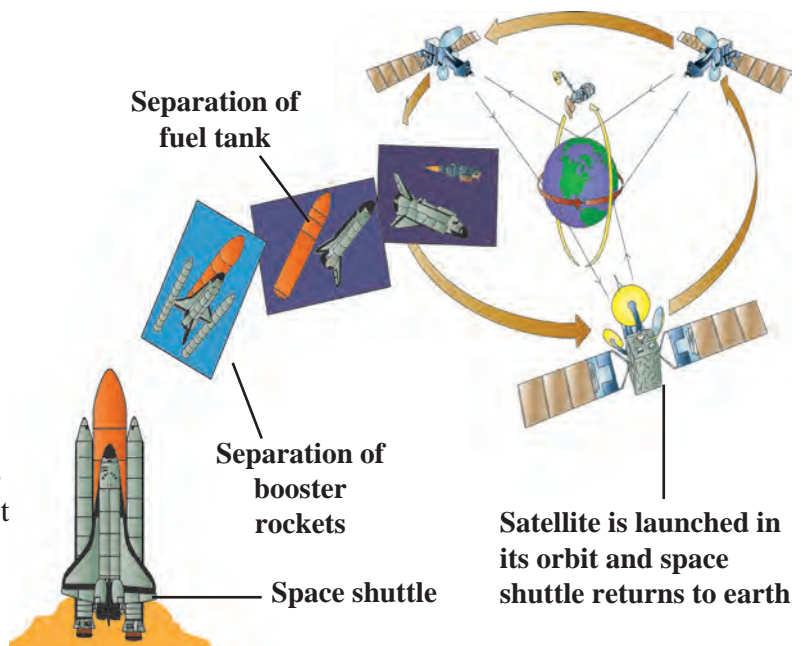

**10.5 b. Space shuttle**

The launch vehicles are costly, because they can be used only once. USA has, therefore, developed space shuttle (fig 10.5b) which returns to the earth except for the fuel tank and can be reused in multiple launches.



## Always Remember

The 'rocket', a type of fire-cracker used in Diwali, is also a sort of launcher. In this rocket, the fuel is ignited using a fuse and the rocket is projected into the sky just like a satellite launcher. Similarly, if a balloon is blown and released with its end open, the air in the balloon is forcefully ejected and the balloon is pushed in opposite direction. This can be explained using the Newton's third law of motion.

## Space missions away from earth

As we have seen above, artificial satellites are being used for making our life more and more enriched. However, in the previous standard, we have learnt about how the telescopes aboard artificial satellites are used to gather information about various objects in the universe. Similarly some space missions are used to gain further knowledge about the universe. In these missions, spacecrafts are sent to the nearby objects in the solar system to observe them more closely. New information has been obtained from such missions and it is helping us to understand the creation and evolution of our solar system.

For such missions, the spacecrafts must escape the earth's gravitational force to travel into the outer space. To achieve this, the initial velocity of the moving object must be greater than the escape velocity of the earth as we have learnt in the Chapter on Gravity. Escape velocity on a planet can be obtained using following formula:

$$v_{\text{esc}} = \sqrt{\frac{2GM}{R}}$$

$G$  = Gravitational constant =  $6.67 \times 10^{-11} \text{ N m}^2/\text{kg}^2$

$M$  = mass of the planet =  $6 \times 10^{24} \text{ kg}$  (for earth)

$R$  = Radius of the planet =  $6.4 \times 10^6 \text{ m}$  (for earth)

$$v_{\text{esc}} = \sqrt{\frac{2 \times 6.67 \times 10^{-11} \times 6 \times 10^{24}}{6.4 \times 10^6}} = 11.18 \times 10^3 \text{ m/s} = 11.18 \text{ km/s}$$

Thus, if a spacecraft is to escape the earth's gravitational force to travel to the outer space, it must have minimum velocity of 11.2 km/s.



## Do you know ?

The astronomical object closest to us is the moon. Light takes 1s to reach from moon to the earth. It means that if we travel with the speed of light, it will take 1s to reach the moon. However, since a spacecraft travels at much smaller speed, it takes longer time to reach the moon. The shortest time taken by a spacecraft to reach the moon, so far, is 8 hours and 36 minutes.

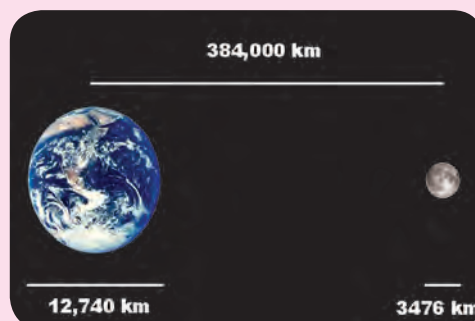



## Moon missions

Since the moon is the closest astronomical object to us, the first space missions to objects in the solar system were the missions to the moon. Such missions have so far been executed by USA, Soviet Union, European countries, China, Japan and India. The space crafts in the Luna series sent by Soviet Union reached near the moon. Luna 2, launched in 1959 was first such craft. After that, till 1975, 15 space crafts made chemical analysis of the moon and also measured its gravity, density and radiations. Last four crafts even landed on the moon and brought the samples of stones on the moon for analysis in the laboratories. All these missions were unmanned.

America also executed moon missions from 1962 to 1972. The specialty of these missions was that some of these were manned missions. In July, 1969, Neil Armstrong became the first human to step on the moon. In 2008, Indian Space Research Organization (ISRO) successfully launched Chandrayaan- 1 and placed it into an orbit around the moon. It sent useful information to earth for about a year. The most important discovery made during the mission was the presence of water on the moon surface. India was the first country to discover this.

## Mars missions

Next to the moon, the astronomical object nearest to the earth is the Mars. Many nations sent space crafts to the Mars. Mars mission is difficult and almost half the missions were unsuccessful. However, ISRO's performance in this mission is remarkable and we all must be proud of it. The spacecraft '*Mangalyaan*' made by ISRO using minimum expenses was launched in November, 2013 and was placed into orbit around the Mars in September, 2014. It obtained very useful information about the surface of the Mars and the atmosphere around it.



**Rakesh Sharma**

Rakesh Sharma was the first Indian to travel to space. He went into space along with two Russian astronauts under the joint Indo - USSR space programme. He stayed in space for 8 days.



**Kalpana Chawla**

Kalpana Chawla obtained her Engineering in Aeronautics degree from Punjab and in 1988 obtained her doctorate from University of Colorado. She was in space for 336 hrs during research mission. While returning to earth from space, on 1<sup>st</sup> February, 2003, the Columbia space craft exploded and Kalpana perished.



**Sunita Williams**

Sunita Williams travelled to the international space station in space shuttle Discovery in 2006. She worked for 29 hrs outside the space station. She created a record by staying for 192 days in space.

## Missions to other planets

Many missions have been executed to study other planets also. In some of these missions the space crafts orbited the planets, some landed on the planets and some just passed near the planet and observed them. Additionally, spacecrafts have been sent to observe asteroids and comets and they have successfully collected some dust and stones from the asteroids and brought them back on the earth. We are getting very useful information from all these missions clarifying our concepts about the origin and evolution of the solar system.



## India and space technology

India also has made remarkable progress in the science and technology of launch vehicles. Various types of launch vehicles have been developed to put satellites having weight up to 2500 kg, into all types of orbits. PSLV and GSLV are two important launchers. The scientific and technological feats achieved by India in this field have a significant contribution to the national and social development. INSAT and GSAT satellite series is actively working in the field of telecommunication, television broadcasting and meteorological services. Availability of television, telephone and internet services all over the nation has been possible due to these satellites only. EDUSAT satellite in this series is used specially in the field of education. IRS satellite series is working for monitoring and management of natural resources and disaster management. To exactly locate position of any place on the earth's surface in terms of its precise latitude and longitude, the IRNSS satellite series has been established.

### Read about:

#### Satellite Launch Centers:

1. Thumba, Thiruvananthapuram
2. Sriharikota
3. Chandipur, Odisha

#### Space Research Organizations:

1. Vikram Sarabhai Space Center, Thiruvananthapuram
2. Satish Dhawan Space Research Center, Sriharikota
3. Space Application Center, Ahmedabad

### Introduction to scientists

Vikram Sarabhai is considered as the father of Indian space program. His efforts led to foundation of Physical Research Laboratory (PRL) at Ahmedabad. In 1962, Indian government constituted 'Indian National Committee for Space Research' under his Chairmanship and first satellite launch center was established at Thumba in 1963. The launching of India's first satellite 'Aryabhata' into the space, was the result of his efforts. He played an important role in the establishment of Indian Space Research Organization (ISRO).



### Space Debris and its management

In addition to the artificial satellite, some other objects are also revolving around the earth. It includes, non-functional satellites, parts of the launcher detached during launching and debris generated due to collision of satellite with other satellite or any other object in the space. According to one estimation made in 2016, there are about 2 crore pieces of length more than 1 cm, revolving around the earth! All this is nothing but the debris in space.

This debris can be harmful to the artificial satellites. It can collide with these satellites or space crafts and damage them. This debris is increasing day by day. Soon, it will be difficult to launch new spacecrafts. It is, therefore, very essential to manage the debris. Some studies and experiments are being done with this in view. Hope that soon we will have a solution for this problem and the future satellites and spacecrafts will not be in danger any more.

**Books are my friends:** For more information read the reference books in your library.

1. Space and science - Dr. J V Narlikar.
2. Story of ISRO - Dr. V. R. Gowariker.

## Exercise

### 1. Fill in the blanks and explain the statements with reasoning:

- a. If the height of the orbit of a satellite from the earth surface is increased, the tangential velocity of the satellite will ...
- b. The initial velocity (during launching) of the Managalyaan, must be greater than .....of the earth.

### 2. State with reasons whether the following sentences are true or false

- a. If a spacecraft has to be sent away from the influence of earth's gravitational field, its velocity must be less than the escape velocity.
- b. The escape velocity on the moon is less than that on the earth.
- d. A satellite needs a specific velocity to revolve in a specific orbit.
- e. If the height of the orbit of a satellite increases, its velocity must also increase.

### 3. Answer the following questions:

- a. What is meant by an artificial satellite? How are the satellites classified based on their functions?
- b. What is meant by the orbit of a satellite? On what basis and how are the orbits of artificial satellites classified?
- c. Why are geostationary satellites not useful for studies of polar regions?
- d. What is meant by satellite launch vehicles? Explain a satellite launch vehicle developed by ISRO with the help of a schematic diagram.
- e. Why it is beneficial to use satellite launch vehicles made of more than one stage?

### 4. Complete the following table.

IRNSS		
	Weather study & predict	
		Earth's observation

### 5. Solve the following problems.

- a. If mass of a planet is eight times the mass of the earth and its radius is twice the radius of the earth, what will be the escape velocity for that planet?

**Ans : 22.4 km/s**

- b. How much time a satellite in an orbit at height 35780 km above earth's surface would take, if the mass of the earth would have been four times its original mass?

**Ans : ~ 12 hrs**

- c. If the height of a satellite completing one revolution around the earth in  $T$  seconds is  $h_1$  meter, then what would be the height of a satellite taking  $2\sqrt{2}T$  seconds for one revolution?

**Ans :  $R + 2h_1$**

### Project :

1. Collect information about the space missions undertaken by Sunita Williams.
2. Assume that you are interviewing Sunita Williams. Prepare a questionnaire and also the answers.



# *Practical Notebook for Standard Ten*

## *Practical Notebook Cum Journal - Science and Technology*

**English  
Medium**

**Price  
₹ 36.00**

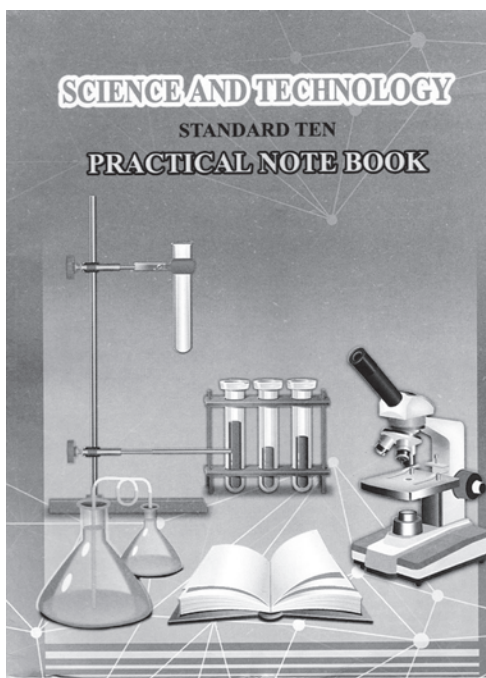

- Based on Government approved syllabus and textbook
- Inclusion of practicals based on all chapters as per Evaluation scheme.
- With full of various activities, pictures, figures/ diagrams, etc.
- Inclusion of objective/multiple choice questions
- Inclusion of useful questions for oral examination
- More questions for practice and separate space for writing answers

***Practical notebooks are available for sale in the regional depots of the Textbook Bureau.***

(1) Maharashtra State Textbook Stores and Distribution Centre, Senapati Bapat Marg, Pune 411004 ☎ 25659465  
(2) Maharashtra State Textbook Stores and Distribution Centre, P-41, Industrial Estate, Mumbai - Bengaluru Highway, Opposite Sakal Office, Kolhapur 416122 ☎ 2468576 (3) Maharashtra State Textbook Stores and Distribution Centre, 10, Udyognagar, S. V. Road, Goregaon (West), Mumbai 400062 ☎ 28771842  
(4) Maharashtra State Textbook Stores and Distribution Centre, CIDCO, Plot no. 14, W-Sector 12, Wavanja Road, New Panvel, Dist. Rajgad, Panvel 410206 ☎ 274626465 (5) Maharashtra State Textbook Stores and Distribution Centre, Near Lekhanagar, Plot no. 24, 'MAGH' Sector, CIDCO, New Mumbai-Agra Road, Nashik 422009 ☎ 2391511 (6) Maharashtra State Textbook Stores and Distribution Centre, M.I.D.C. Shed no. 2 and 3, Near Railway Station, Aurangabad 431001 ☎ 2332171 (7) Maharashtra State Textbook Stores and Distribution Centre, Opposite Rabindranath Tagore Science College, Maharaj Baug Road, Nagpur 440001 ☎ 2547716/2523078 (8) Maharashtra State Textbook Stores and Distribution Centre, Plot no. F-91, M.I.D.C., Latur 413531 ☎ 220930 (9) Maharashtra State Textbook Stores and Distribution Centre, Shakuntal Colony, Behind V.M.V. College, Amravati 444604 ☎ 2530965



**ebalbharati**

E-learning material (Audio-Visual) for Standards One to Twelve is available through Textbook Bureau, Balbharati...

- Register your demand by scanning the Q.R. Code given alongside.
- Register your demand for E-learning material by using Google play store and downloading ebalbharati app.  
[www.ebalbharati.in](http://www.ebalbharati.in), [www.balbharati.in](http://www.balbharati.in)





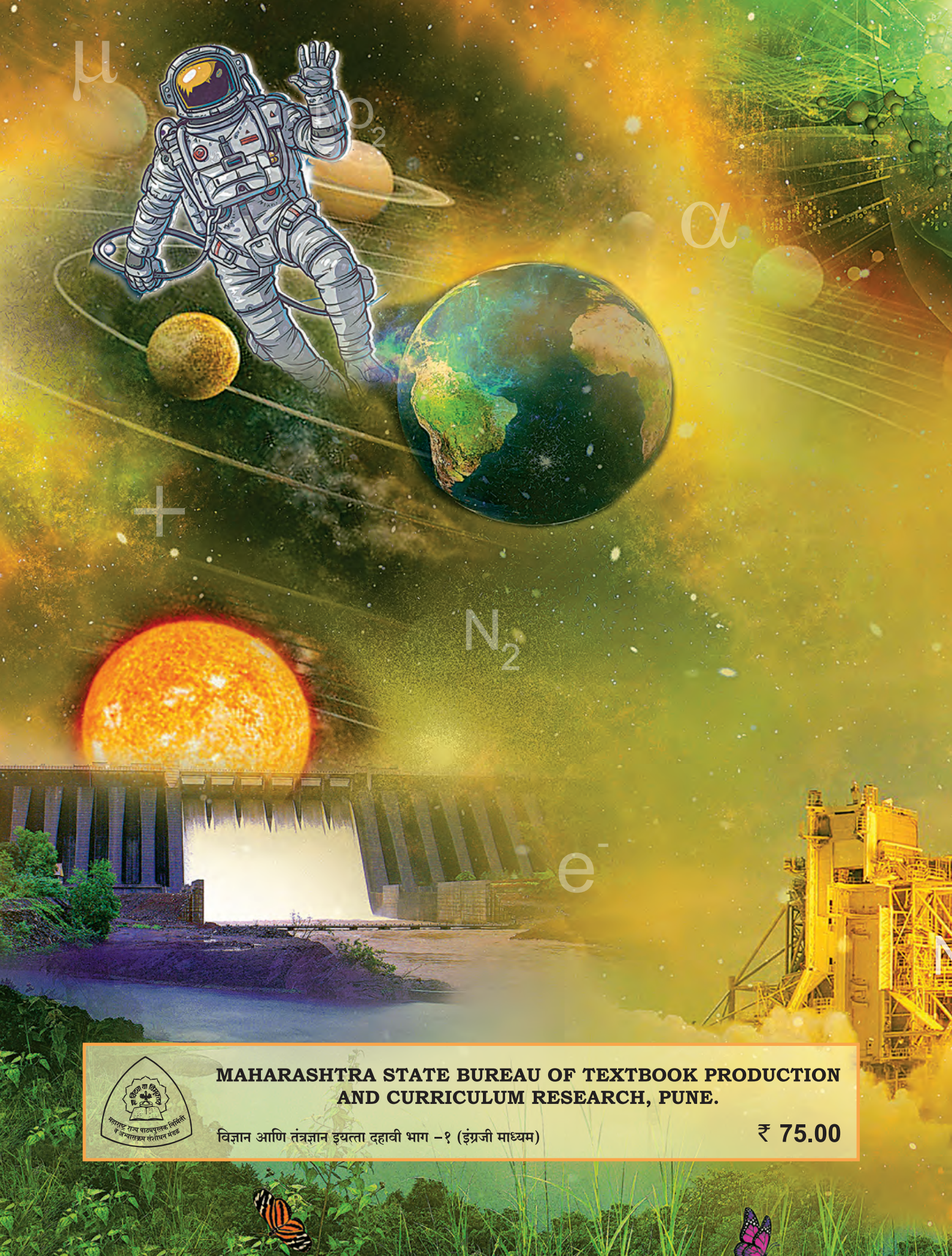

**MAHARASHTRA STATE BUREAU OF TEXTBOOK PRODUCTION  
AND CURRICULUM RESEARCH, PUNE.**

विज्ञान आणि तंत्रज्ञान इयत्ता दहावी भाग -१ (इंग्रजी माध्यम)

**₹ 75.00**